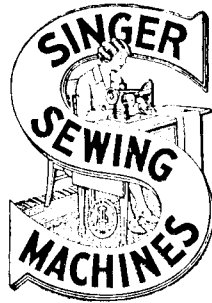


SINGER

149-2,-4

LIST OF PARTS



MACHINES Nos. 149-2 and 149-4

THE SINGER MANUFACTURING COMPANY

INDEX

ACCESSORIES.....	PA
BENCH STAND.....	
EDGE FOLDERS.....	
FOLDER ON SHANK.....	
FOOT LIFTER PARTS.....	
KNEE LIFTER PARTS.....	
LAP SEAM FELLERS.....	
MACHINE BASE WITH BELT GUARD.....	
MACHINE No. 149-2.....	
" " 149-4.....	
NUMERICAL LIST OF PARTS.....	
OBsolete PARTS.....	
STRIP FOLDERS.....	
TAPE HOLDERS.....	
THREAD UNWINDER (FOR FOUR SPOOLS).....	
" " (FOR EIGHT SPOOLS).....	

Copyright © 1929 by Singer Manufacturing Company

NO.	PLATE	NAME
128506	9451	Arm Rotary Shaft Ball Bearing Case Cap with 128619
128619	9462	Arm Rotary Shaft Ball Bearing Case Cap Pad (felt)
205f	9465	Arm Rotary Shaft Ball Bearing Case Cap Screw
308c	9467	Arm Rotary Shaft Ball Bearing Case Cap Set Screw
54007	9451	Arm Rotary Shaft Bushing (intermediate)
54089	—	“ “ “ “ “ “ 54007 with 64508 and 64805
64508	9462	Arm Rotary Shaft Bushing (intermediate) Oil Pad (braided cotton) long
64805	9462	Arm Rotary Shaft Bushing (intermediate) Oil Pad (braided cotton) short
888c	9466	Arm Rotary Shaft Bushing (intermediate) Set Screw
128507	9456	Arm Rotary Shaft Bushing (front)
50999c	9465	“ “ “ “ “ “ Set Screw
128508	9454	Arm Rotary Shaft Collar with two 1258c
1258c	9466	“ “ “ “ “ Set Screw
49013	9462	“ “ “ Front Bearing Oil Pad (braided cotton)
128509	9451	Balance Wheel, 2 in. pulley, with two 430c
128510	9451	“ “ Cover
144r	9467	“ “ “ Screw
430c	9466	“ “ “ Set Screw
128633	9452	Cloth Plate
128513	9462	“ “ Oil Tube with 49092, for oiling 128520
49092	9462	Cloth Plate Oil Tube Packing (felt)
128514	9452	“ “ Slide
38416	9456	“ “ “ Spring
725j	9465	“ “ “ “ Screw
128515	—	Cloth Plate Slide complete, Nos. 128514, two 38416 and four 725j
128634	—	Cloth Plate complete, Nos. 128513, 128515, 128633 and two 4198c
4011f	9465	Cloth Plate Screw (left)
50473f	9465	“ “ “ (right)
128635	9453	Feed Bar with two 453c
128636	—	“ “ 128635 with 128519 and two 190b
128707	—	Feed Bar 128636 with 57225 and 128533
57225	9453	“ “ Hinge Pin
453c	9466	“ “ “ “ Set Screw

NO.	PLATE	NAME
12366	9462	Feed Bar Oil Pad (braided cotton)
128518	9455	“ “ Wearing Block
128519	9454	“ “ “ Plate
190b	9465	“ “ “ “ Screw
128520	9453	“ Connection (forked) with 453c and 769c
128615	—	Feed Connection 128520 with 4095r, 128522, 128528, 128532 and two 128524
769c	9465	Feed Connection Clamping Screw
453c	9466	“ “ Set Screw
128524	9455	“ “ Slide Block Section
128522	9455	“ “ “ “ Sleeve
4095r	9465	“ “ “ “ “ Cap Screw
128772	9469	Feed Dog, 19 teeth (16 teeth to the inch) with 452c; for 1/4 in. to 7/8 in. gauges
128729	9470	Feed Dog, 19 teeth (16 teeth to the inch) with 452c; for 1/2 in. to 1 1/8 in. gauges
128716	9471	Feed Dog, 19 teeth (16 teeth to the inch) with 452c; for 3/4 in. to 7/8 in. gauges
128726	9472	Feed Dog, 19 teeth (16 teeth to the inch) with 452c; for 1 1/8 in. to 1 1/4 in. gauges
128731	9473	Feed Dog, 19 teeth (16 teeth to the inch) with 452c; for 1 3/8 in. to 1 3/4 in. gauges
128824	9474	Feed Dog, 19 teeth (16 teeth to the inch) with 452c; for 1 3/4 in. to 1 7/8 in. gauges
452c	9466	Feed Dog Adjusting Screw
457b	9465	“ “ Screw
128638	9454	“ Lifting Eccentric with two 452c
452c	9466	“ “ “ Set Screw
50944c	9467	“ Regulating Screw
128526	9455	“ “ “ Plate
391d	9465	“ “ “ “ Screw
128527	9455	“ Regulator with two 443c
128528	—	Feed Regulator complete, Nos. 391d, 399b, 50944c, 128526, 128527, 128530 and 128534
128529	9457	Feed Regulator Bushing
50999b	9465	“ “ “ Set Screw
4403b	9462	“ “ Oil Pad (felt)
443c	9467	“ “ Set Screw
128530	9455	“ “ Slide Block
128531	9455	“ “ “ “ Stop
399b	9465	“ “ “ “ “ Screw
128532	9455	“ “ “ “ Washer
128533	9453	“ Rocking Frame with two each 453c and 4324c

From the library of: Diamond Needle Corp

NO.	PLATE	NAME
50370b	9465	Needle Bar Connecting Link Hinge Pin Set Screw.
128558	9452	Needle Bar Lever with 50282c, 50370b and two 1259c.
128618	---	Needle Bar Lever 128558 with 128557 and 128713.
50943c	9456	Needle Bar Lever Ball Screw Stud.
1259c	9466	" " " " " " Set Screw.
128559	9463	Needle Bar Lever Connecting Rod with 683e, 51897, 128560, 128561, 128628 and four 896e.
*128560	---	Needle Bar Lever Connecting Rod Cap (lower).
896e	9465	Needle Bar Lever Connecting Rod Cap (lower) Screw.
*128561	---	Needle Bar Lever Connecting Rod Cap (upper).
896e	9465	Needle Bar Lever Connecting Rod Cap (upper) Screw.
42077	9456	Needle Bar Lever Connecting Rod Cap Guide.
171e	9465	Needle Bar Lever Connecting Rod Cap Guide Screw.
51897	9456	Needle Bar Lever Connecting Rod Cap Oil Cup.
128628	9462	Needle Bar Lever Connecting Rod Cap Oil Pad (braided cotton).
683e	9465	Needle Bar Lever Connecting Rod Cap Oil Pad Stop Screw.
128562	9453	Needle Bar Lever Hinge Pin.
128563	9456	" " " " " Bushing (back).
443c	9466	Needle Bar Lever Hinge Pin Bushing (back) Set Screw.
128564	9456	Needle Bar Lever Hinge Pin Bushing (front).
743c	9466	Needle Bar Lever Hinge Pin Bushing (front) Set Screw.
51648	9462	Needle Bar Lever Hinge Pin Bushing (front) Oil Pad (braided cotton).
50282e	9465	Needle Bar Lever Set Screw.
128767	9456	" Clamp with two 50379e.
50379e	9465	" Set Screw.
*128567	---	Oil Cup for 128568.
128569	9463	" " Pad (felt).
*128570	---	" " Tube.

NO.	PLATE	NAME
128571	9462	Oil Cup Tube Wick (braided cotton).
128568	9463	Oil Cup complete, for oiling 128550, Nos. 128567 and 128569 to 128571.
792c	9465	Oil Cup Screw for 128568.
128572	" "	" " for 128573.
128574	" "	" " Bracket.
44006	9463	" " Pad (felt).
128575	" "	" " Tube (long).
128576	" "	" " (short).
128574	9462	" " Wick (braided cotton).
128573	9463	Oil Cup complete, for oiling 128538, Nos. 44006, 128572, 128574 to 128576 and two 128571.
1239e	9465	Oil Cup Screw for 128573.
128577	" "	" Tube for 128725.
49092	9462	" " Packing (felt).
128725	9463	" " Bracket and Thread Guide with 49092 and 128577.
61477	9457	Presser Bar with 25303.
25303	9457	" " Ball, size 1/4 in.
61046	9457	" " Bushing (lower).
1133E	9466	" " " " " Set Screw.
38456	9456	" " " (upper).
1133E	9466	" " " " " Set Screw.
128580	9457	" " Guide Bracket with 175c and 154c.
175c	9465	Presser Bar Guide Bracket Adjusting Screw.
128581	9457	Presser Bar Guide Bracket Guide.
157c	9466	" " " " " " Set Screw.
154c	9466	Presser Bar Guide Bracket Set Screw.
128582	9457	" " Lifter.
57258	9457	" " Hinge Stud.
443c	9466	" " " " " " Set Screw.
51871	9457	" " " Roller and Stud.
50603e	9467	" " " Stop Screw.
128583	9457	" " Lifting Bracket with 465c and 51871.
128584	9452	Presser Bar Lifting Lever.
61075	9457	" " " " " Connecting Stud.
465c	9466	Presser Bar Lifting Lever Connecting Stud Set Screw.
802b	9466	Presser Bar Lifting Lever Hinge Screw.
54040	9464	" " Spring (flat).
38468	9457	" " " Stud.

NO.	PLATE	NAME
128733	9468	Presser Foot Extension with two 62527
128734	9468	" " " Connection
1145D	9468	" " " "
		Hinge Screw.....
62527	9468	Presser Foot Extension Hinge Pin.....
18055	9468	" " Hinge Pin.....
128735	-----	" " Plate.....
128647	-----	" " Shank with 563J and 1700J
563J	9468	" " " Adjusting Screw....
1700J	9468	" " " " " Nut
2656	9468	" " Spring.....
128736	9468	Presser Foot (hinged extension and hinged plate) complete, for obtaining a smooth finish on broadcloth shirt centres, Nos. 18055, 128647, 128733, 128735 and two each 1145D, 2656 and 128731.....
18055	9468	Presser Foot Hinge Pin.....
128718	-----	" " Plate.....
128647	-----	" " Shank with 563J and 1700J
563J	9468	" " " Adjusting Screw....
1700J	9468	" " " " " Nut
128719	9468	Presser Foot (hinged) complete, for shirt centres, Nos. 18055, 128647 and 128718.....
190D	9465	Presser Foot Screw.....
574W	9467	Pressure Regulating Thumb Screw.....
1539W	9467	" " " " Lock Nut.....
128587	9461	Slack Thread Controller.....
46035	9461	" " " Clamp.....
176D	9465	" " " " Screw....
128720	9461	" " Regulator.....
128589	9461	" " " Holder with 452C.....
128590	9461	Slack Thread Regulator Holder Crank with 175D.....
175D	9465	Slack Thread Regulator Holder Crank Clamping Screw.....
128591	9461	Slack Thread Regulator Holder Crank Driver with 456C and 1963.....
1963	9461	Slack Thread Regulator Holder Crank Driver Roller and Stud.....
456C	9466	Slack Thread Regulator Holder Crank Driver Set Screw.....
452C	9466	Slack Thread Regulator Set Screw.....

NO.	PLATE	NAME
128649	9461	Tension (under thread) Bracket.....
997E	9465	" " " " Screw
50944E	9467	" " " " Stud.....
2102	9461	Tension (under thread) Disc.....
1560C	9466	" " " Regulating Thumb Nut.....
916C	9467	Tension (under thread) Screw Stud....
44209	-----	" " " " " " 916C with 1560C.....
10148	9461	Tension (under thread) Spring.....
17547	9461	" " " Thread Guide..
128592	9451	" (upper thread) Bracket.....
376D	9465	" " " " Screw....
2102	9461	" " " Disc.....
51570C	9466	" " " Regulating Thumb Nut.....
32572	9461	Tension (upper thread) Releasing Disc.....
54988	9461	" " " " Pin....
54989	9461	" " " " Shaft
54872	9461	" " " " " Crank with 624C.....
128593	9461	Tension (upper thread) Releasing Shaft Crank Connecting Link.....
110D	9465	Tension (upper thread) Releasing Shaft Crank Connecting Link Hinge Screw.....
624C	9466	Tension (upper thread) Releasing Shaft Crank Set Screw.....
54990	9459	Tension (upper thread) Releasing Shaft Spring.....
316C	9466	Tension (upper thread) Releasing Shaft Stop Screw.....
1547J	9466	Tension (upper thread) Releasing Shaft Stop Screw Nut.....
50326C	9467	Tension (upper thread) Screw Stud....
59539	-----	Tension (upper thread) Screw Stud 50326C with 51570C.....
59535	9459	Tension (upper thread) Spring.....
59537	9459	" " " " Bushing (large).....
59538	9459	Tension (upper thread) Spring Bushing (small).....
17547	9461	Tension (upper thread) Thread Guide..
128650	9459	Thread (under) Eyelet.....
1521J	9466	" " " Nut.....
128774	9459	" " Guide (left) for $\frac{3}{16}$ in. to $\frac{5}{16}$ in. gauges.....

NO.	PLATE	NAME
128651	9459	Thread (under) Guide (left) for $\frac{3}{8}$ in. to $1\frac{1}{2}$ in. gauges.....
	NOTE:	When ordering Nos. 128651 or 128774, state gauge required.
128775	9459	Thread (under) Guide (right) for $\frac{3}{16}$ in. to $\frac{5}{16}$ in. gauges.....
128652	9459	Thread (under) Guide (right) for $\frac{3}{8}$ in. to $1\frac{1}{2}$ in. gauges.....
	NOTE:	When ordering Nos. 128652 or 128775 state gauge required.
128653	9459	Thread (under) Guide Holder.....
446c	9466	" " " " Set Screw
176d	9465	" " " Screw for 128651 and 128652.....
185d	9465	Thread (under) Guide Screw for 128774 and 128775.....
128654	9463	Thread (under) Protector.....
1235f	9465	" " " Screw.....
46009	9459	" (upper) Eyelet.....
128721	9459	" " " for 128558.....
190d	9465	" " " Screw.....
50945c	9467	" " " " Stud for 46009.....
2102	9461	Thread (upper) Nipper Disc.....
51570c	9466	" " " Regulation Thumb Nut.....
128604	9459	Thread (upper) Nipper Regulator.....
190d	9465	" " " " Adjusting Screw.....
32572	9461	Thread (upper) Nipper Releasing Disc
128605	9459	" " " " Pin
51029c	9467	" " " Screw Stud
128714	---	" " " " "
		51029c with 51570c.....
128656	9459	Thread (upper) Nipper Spring.....
59537	9459	" " " " Bushing (large).....
59538	9459	Thread (upper) Nipper Spring Bushing (small).....
128606	9459	Thread (upper) Nipper Thread Guide...
128722	9459	" " Take-up.....
50379f	9465	" " " Set Screw...
128773	9469	Throat Plate with 128724 and two 665d, for 128772.....
128730	9470	Throat Plate with 128724 and two 665d, for 128729.....

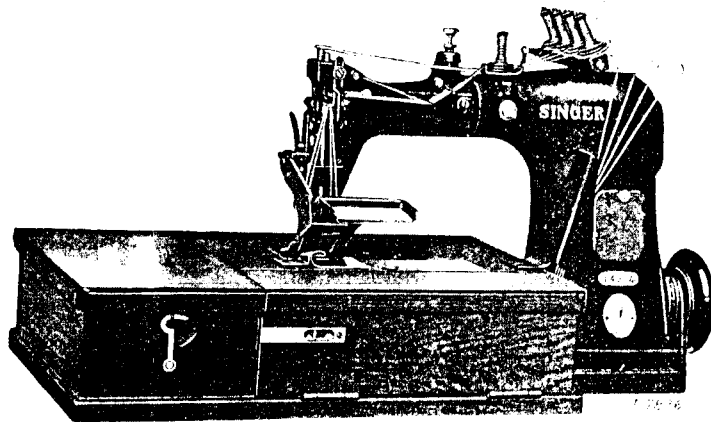
NO.	PLATE	NAME
128723	9471	Throat Plate with 128724 and two 665d, for 128716.....
128737	9475	Throat Plate with 128724 and two 665d, for 128736, for 128716.....
128727	9472	Throat Plate with 128724 and two 665d, for 128726.....
128770	9475	Throat Plate with 128724 and two 665d, for obtaining a smooth finish on broad-cloth shirt centres, for 128726.....
128732	9473	Throat Plate with 128724 and two 665d, for 128731.....
128822	9474	Throat Plate with 128724 and two 665d, for 128821.....
128612	9463	Throat Plate Holder.....
50154d	9465	" " " Screw.....
1011f	9465	" " Screw.....
1198c	9465	" " Supporting Screw.....
128724	9472	" " Thread Retainer for 128723, 128727, 128730, 128732, 128737, 128770, 128773 and 128822.....
	NOTE:	When ordering No. 128724 state gauge required.
665d	9465	Throat Plate Thread Retainer Screw...

Genuine Singer Needles and their Containers are marked with the Company's Trade Mark "SIMANCO." 1

Needles in Containers marked "For Singer Machines" are not Singer made needles. 2

LIST OF PARTS COMPLETE

FOR



MACHINE No. 149-4

FOR STITCHING CENTRES ON MEN'S SHIRTS AND OTHER WORK IN FABRICS REQUIRING FOUR-ROW STITCHINGS, FOUR NEEDLES AND FOUR LOOPERS. THE GREATEST DISTANCE BETWEEN THE OUTSIDE NEEDLES IS 1½ INCHES, WHICH CAN BE DIVIDED INTO SMALLER GAUGES BETWEEN EACH NEEDLE AS ORDERED, EXCEPT THAT NONE CAN BE MADE SMALLER THAN 3/16 INCH. SPEED UP TO 3400, ACCORDING TO THE MATERIAL BEING STITCHED.

NO.	PLATE	NAME
*128632	—	Arm, upper and lower (solid).....
128502	9451	" Back Cover.....
190b	9465	" " " Screw.....
128502	9451	" Side Cover.....
286b	9467	" " " Thumb Screw.....
128503	9452	" Rotary Shaft.....
128613	—	" " " 128503 with 50943c and 128559.....
128664	—	Arm Rotary Shaft 128613 with 128663.....
128504	9451	" " " Ball Bearing.....
128505	9451	" " " " " Case.....
128627	—	" " " " " " " 128505 with 128504, 128506 and three 205F.....

PARTS FOR MACHINE No. 149-4

NO.	PLATE	NAME
128506	9451	Arm Rotary Shaft Ball Bearing Case Cap with 128619.....
128619	9462	Arm Rotary Shaft Ball Bearing Case Cap Pad (felt).....
205F	9465	Arm Rotary Shaft Ball Bearing Case Cap Screw.....
30Sc	9467	Arm Rotary Shaft Ball Bearing Case Cap Set Screw.....
54007	9451	Arm Rotary Shaft Bushing (intermediate).....
54089	—	" " " " " " 54007 with 64508 and 64805.....
64508	9462	Arm Rotary Shaft Bushing (intermediate) Oil Pad (braided cotton) long.....
64805	9462	Arm Rotary Shaft Bushing (intermediate) Oil Pad (braided cotton) short.....
88Sc	9466	Arm Rotary Shaft Bushing (intermediate) Set Screw.....
128507	9456	Arm Rotary Shaft Bushing (front).....
50999c	9465	" " " " " Set Screw.....
128508	9454	Arm Rotary Shaft Collar with two 1258c.....
1258c	9466	" " " " " Set Screw.....
49013	9462	" " " Front Bearing Oil Pad (braided cotton).....
128509	9451	Balance Wheel, 2 in. pulley, with two 430c.....
128510	9451	" " " Cover.....
144r	9467	" " " Screw.....
430c	9466	" " " Set Screw.....
128633	9452	Cloth Plate.....
128513	9462	" " Oil Tube with 49092, for oiling 128520.....
49092	9462	Cloth Plate Oil Tube Packing (felt).....
128514	9452	" " Slide.....
38416	9456	" " " Spring.....
725j	9465	" " " " Screw.....
128515	—	Cloth Plate Slide complete, Nos. 128514, two 38416 and four 725j.....
128634	—	Cloth Plate complete, Nos. 128513, 128515, 128633 and two 1198c.....
1011r	9465	Cloth Plate Screw (left).....
50473F	9465	" " " (right).....
128635	9453	Feed Bar with two 453c.....
128636	—	" " 128635 with 128519 and two 190b.....
128707	—	Feed Bar 128636 with 57225 and 128533.....
57225	9453	" " Hinge Pin.....
453c	9466	" " " " " Set Screw.....

From the library of: Diamond Needle Corp

NO.	PLATE	NAME
42366	9462	Feed Bar Oil Pad (braided cotton).....
128518	9455	“ “ Wearing Block.....
128519	9454	“ “ “ Plate.....
190D	9465	“ “ “ Screw.....
128520	9453	“ Connection (forked) with 453c and 769c.....
128615	—	Feed Connection 128520 with 1095F, 128522, 128528, 128532 and two 128521
769c	9465	Feed Connection Clamping Screw.....
453c	9466	“ “ Set Screw.....
128521	9455	“ “ Slide Block Section.....
128522	9455	“ “ “ Sleeve.....
1095F	9465	“ “ “ “ “ Cap Screw.....
128738	9476	Feed Dog, 19 teeth (16 teeth to the inch) with 452c, for $\frac{3}{16}$ in. to $\frac{1}{4}$ in., $\frac{7}{8}$ in. to $1\frac{1}{8}$ in. and $\frac{3}{16}$ in. to $\frac{1}{4}$ in. gauges....
452c	9466	Feed Dog Adjusting Screw.....
157D	9465	“ “ Screw.....
128638	9454	“ Lifting Eccentric with two 452c....
452c	9466	“ “ “ Set Screw.....
50941c	9467	“ Regulating Screw.....
128526	9455	“ “ “ Plate.....
391D	9465	“ “ “ “ Screw.....
128527	9455	“ Regulator with two 1143c.....
128528	—	Feed Regulator complete, Nos. 391D, 399D, 50941c, 128526, 128527, 128530 and 128531.....
128529	9457	Feed Regulator Bushing.....
50999D	9465	“ “ “ Set Screw.....
41036	9462	“ “ Oil Pad (felt).....
1143c	9467	“ “ Set Screw.....
128530	9455	“ “ Slide Block.....
128531	9455	“ “ “ “ Stop.....
399D	9465	“ “ “ “ “ Screw.....
128532	9455	“ “ “ “ Washer.....
128533	9453	“ Rocking Frame with two each 453c and 1324c.....
1324c	9467	Feed Rocking Frame Adjusting Screw....
128534	9453	“ “ “ Hinge Pin.....
57235	9456	“ “ “ “ “ Bushing.....
453c	9466	“ “ “ “ “ “ Set Screw.....
453c	9466	Feed Rocking Frame Hinge Pin Set Screw
128768	9458	Looper (self threading) with 590D, 61011 and 128702.....

NO.	PLATE	NAME
128739	9458	Looper Carrier with four 50379F.....
128769	—	“ “ “ 128739 with 228D and 128740.....
128537	9455	Looper Carrier Driver.....
*128538	—	“ “ “ “ Connection.....
128630	—	“ “ “ “ “ 128538 with two 128539 and four 896E.....
128621	9455	Looper Carrier Driver Connection complete, Nos. 128630, 128631 and two 142E.....
128663	—	Looper Carrier Driver Connection 128621 with 128537, 128543 to 128547 and 128641.....
*128539	—	Looper Carrier Driver Connection Cap
896E	9465	“ “ “ “ “ “ Screw.....
*128540	—	Looper Carrier Driver Connection End Bearing.....
128631	—	Looper Carrier Driver Connection End Bearing 128540 with 128541.....
*128541	—	Looper Carrier Driver Connection End Bearing Cap.....
142E	9465	Looper Carrier Driver Connection End Bearing Cap Screw.....
128641	9455	Looper Carrier Driver Eccentric with 791c and two 452c.....
791c	9466	Looper Carrier Driver Eccentric Position Screw.....
452c	9466	Looper Carrier Driver Eccentric Set Screw.....
128543	9454	Looper Carrier Holder with two 896E....
896E	9465	“ “ “ Clamping Screw
128544	9453	“ “ “ Rock Shaft.....
128545	9453	“ “ “ “ Hinge Pin....
443c	9466	“ “ “ “ “ “ Set Screw.....
128546	9454	Looper Carrier Rock Shaft Nut.....
128547	9454	“ “ “ “ “ “ Clamp with 175D.....
175D	9465	Looper Carrier Rock Shaft Nut Clamp Screw.....
898c	9465	Looper Carrier Screw.....
128728	9454	“ Eccentric with two 51137c.....
128665	—	“ “ “ 128728 with 1664E, 50942c, 128549, 128624 and two 55545
51137c	9466	Looper Eccentric Set Screw.....
128549	9454	“ “ “ Sleeve.....

NO.	PLATE	NAME
128550	9454	Looper Eccentric Sleeve Connection with 128552 and two 175E.....
128624	---	Looper Eccentric Sleeve Connection 128550 with 679c.....
679c	9454	Looper Eccentric Sleeve Connection Ball Screw Stud.....
1520j	9454	Looper Eccentric Sleeve Connection Ball Screw Stud Nut.....
128551	9454	Looper Eccentric Sleeve Connection Ball Screw Stud Nut Lock Washer.....
*128552	---	Looper Eccentric Sleeve Connection Cap 175E 9465
50942E	9467	Looper Eccentric Sleeve Connection Hinge Screw.....
1664E	9466	Looper Eccentric Sleeve Connection Hinge Screw Nut.....
55515	9462	Looper Eccentric Sleeve Connection Oil Hole Packing (braided cotton).....
50379F	9465	Looper Set Screw.....
128702	9458	" Thread Guard.....
61041	9458	" " " Pin.....
590D	9458	" " " Screw.....
128740	9458	" " Guide.....
NOTE: When ordering No. 128740, state gauge required		
228D	9465	Looper Thread Guide Screw.....
57244	9456	Needle Bar (hollow).....
61181	---	" " 57244 with 61094.....
38456	9456	" " Bushing (lower).....
1133E	9466	" " " " Set Screw..
128554	9456	" " " (upper).....
1133E	9466	" " " " Set Screw..
128555	9456	" " Connecting Bracket with 1057D, 50370D and 50379F.....
128713	---	Needle Bar Connecting Bracket 128555 with 128556 and 128557.....
1057D	9465	Needle Bar Connecting Bracket Clamping Screw.....
128556	9456	Needle Bar Connecting Link.....
128557	9456	" " " " Hinge Pin
50370D	9465	" " " " " " Set Screw.....
128558	9452	Needle Bar Lever with 50282E, 50370D and two 1259c.....

NO.	PLATE	NAME
128618	---	Needle Bar Lever 128558 with 128557 and 128713.....
50943c	9456	Needle Bar Lever Ball Screw Stud.....
1259c	9466	" " " " " " Set Screw.....
128559	9463	Needle Bar Lever Connecting Rod with 683F, 54897, 128560, 128561, 128628 and four 896E.....
*128560	---	Needle Bar Lever Connecting Rod Cap (lower).....
896E	9465	Needle Bar Lever Connecting Rod Cap (lower) Screw.....
*128561	---	Needle Bar Lever Connecting Rod Cap (upper).....
896E	9465	Needle Bar Lever Connecting Rod Cap (upper) Screw.....
42077	9456	Needle Bar Lever Connecting Rod Guide 171E 9465
54897	9456	Needle Bar Lever Connecting Rod Oil Cup.....
128628	9462	Needle Bar Lever Connecting Rod Oil Pad (braided cotton).....
683F	9465	Needle Bar Lever Connecting Rod Oil Pad Stop Screw.....
128562	9453	Needle Bar Lever Hinge Pin.....
128563	9456	" " " " " Bushing (back).....
443C	9466	Needle Bar Lever Hinge Pin Bushing (back) Set Screw.....
128564	9456	Needle Bar Lever Hinge Pin Bushing (front).....
743c	9466	Needle Bar Lever Hinge Pin Bushing (front) Set Screw.....
54648	9462	Needle Bar Lever Hinge Pin Bushing (front) Oil Pad (braided cotton).....
50282E	9465	Needle Bar Lever Set Screw.....
61094	9458	" Clamp with four 50014F.....
50014F	9466	" Set Screw.....
*128567	---	Oil Cup for 128568.....
128569	9463	" " Pad (felt).....
*128570	---	" " Tube.....
128571	9462	" " " Wick (braided cotton)....
128568	9463	Oil Cup complete, for oiling 128550, Nos. 128567 and 128569 to 128571.....
792c	9465	Oil Cup Screw for 128568.....
*128572	---	" " for 128573.....

NO.	PLATE	NAME
*128574	—	Oil Cup Bracket.....
44006	9463	“ “ Pad (felt).....
*128575	—	“ “ Tube (long).....
*128576	—	“ “ “ (short).....
128571	9462	“ “ “ Wick (braided cotton)....
128573	9463	Oil Cup complete, for oiling 128538, Nos. 44006, 128572, 128574 to 128576 and two 128571.....
1239F	9465	Oil Cup Screw for 128573.....
*128577	—	“ Tube for 128741.....
49092	9462	“ “ Packing (felt).....
128741	9463	“ “ Bracket and Thread Guide with 49092 and 128577.....
61477	9457	Presser Bar with 25303.....
25303	9457	“ “ Ball, size $\frac{1}{4}$ in.....
61046	9457	“ “ Bushing (lower).....
1133E	9466	“ “ “ “ Set Screw..
38456	9456	“ “ “ (upper).....
1133E	9466	“ “ “ “ Set Screw..
128580	9457	“ “ Guide Bracket with 175c and 454c.....
175c	9465	Presser Bar Guide Bracket Adjusting Screw.....
128581	9457	Presser Bar Guide Bracket Guide.....
457c	9466	“ “ “ “ “ “ Set Screw.....
454c	9466	Presser Bar Guide Bracket Set Screw..
128582	9457	“ “ Lifter.....
57258	9457	“ “ “ Hinge Stud.....
443c	9466	“ “ “ “ “ Set Screw
51871	9457	“ “ “ Roller and Stud.....
50603E	9467	“ “ “ Stop Screw.....
128583	9457	“ “ Lifting Bracket with 465c and 51871.....
128584	9452	Presser Bar Lifting Lever.....
61075	9457	“ “ “ “ Connecting Stud.....
465c	9466	Presser Bar Lifting Lever Connecting Stud Set Screw.....
802b	9466	Presser Bar Lifting Lever Hinge Screw..
128742	9464	“ “ “ “ Spring.....
54040	9464	“ “ Spring (flat).....
38468	9457	“ “ “ Stud.....
18055	9468	“ Foot Hinge Pin.....
128743	—	“ “ Plate.....
128647	—	“ “ Shank with 563J and 1700J

NO.	PLATE	NAME
563J	9468	Presser Foot Shank Adjusting Screw..
1700J	9468	“ “ “ “ “ Nut
128741	9468	Presser Foot (hinged) complete, Nos. 18055, 128647 and 128743.....
190b	9465	Presser Foot Screw.....
571w	9467	Pressure Regulating Thumb Screw.....
4539w	9467	“ “ “ “ Lock Nut.....
128745	9460	Slack Thread Controller.....
54242	9460	“ “ “ Clamp.....
190b	9465	“ “ “ “ Screw..
128746	9460	“ “ Regulator.....
128589	9461	“ “ “ Holder with 452c.
128590	9461	“ “ “ “ Crank with 175b.....
175b	9465	Slack Thread Regulator Holder Crank Clamping Screw.....
128591	9461	Slack Thread Regulator Holder Crank Driver with 456c and 1963.....
1963	9461	Slack Thread Regulator Holder Crank Driver Roller and Stud.....
456c	9466	Slack Thread Regulator Holder Crank Driver Set Screw.....
452c	9466	Slack Thread Regulator Set Screw.....
2102	9461	Tension (under thread) Disc.....
128747	9458	“ “ “ Post.....
1620b	9466	“ “ “ “ Lock Nut
14017	9460	“ “ “ “ “ “ Washer.....
51570c	9466	Tension (under thread) Regulating Thumb Nut.....
50326c	9467	Tension (under thread) Screw Stud.....
59539	—	“ “ “ “ “ 50326c with 51570c.....
46386	9458	Tension (under thread) Separating Disc
59531	9459	“ “ “ Spring.....
59537	9459	“ “ “ “ Bushing (large).....
59538	9459	Tension (under thread) Spring Bushing (small).....
128748	9460	Tension (under thread) Thread Guide..
128749	9464	“ (upper thread) Bracket.....
376b	9465	“ “ “ “ Screw..
2102	9461	“ “ “ Disc.....
51570c	9466	“ “ “ Regulating Thumb Nut.....

NO.	PLATE	NAME
32572	9461	Tension (upper thread) Releasing Disc.
54988	9461	" " " " Pin...
54246	9464	" " " " Shaft
54872	9461	" " " " "
		Crank with 624c.....
54737	9458	Tension (upper thread) Releasing Shaft
		Crank Connecting Link.....
110b	9465	Tension (upper thread) Releasing Shaft
		Crank Connecting Link Hinge Screw..
624c	9466	Tension (upper thread) Releasing Shaft
		Crank Set Screw.....
316c	9466	Tension (upper thread) Releasing Shaft
		Stop Screw.....
1547j	9466	Tension (upper thread) Releasing Shaft
		Stop Screw Nut.....
50326c	9467	Tension (upper thread) Screw Stud.....
59539	-----	" " " " " 50326c
		with 51570c.....
59535	9459	Tension (upper thread) Spring.....
59537	9459	" " " " Bushing
		(large).....
59538	9459	Tension (upper thread) Spring Bushing
		(small).....
57076	9458	Tension (upper thread) Thread Guide
128750	9460	Thread (under) Eyelet.....
1521j	9466	" " " Nut.....
128654	9463	" " Protector.....
1235F	9465	" " " Screw.....
128751	9460	" " Thread Guide, for one
		thread.....
128752	9460	Thread (under) Thread Guide, for two
		threads.....
128753	9460	Thread (under) Thread Guide, for three
		threads.....
128754	9460	Thread (under) Thread Guide, for four
		threads.....
128755	9460	Thread (under) Thread Guide Holder
		with four 1498c.....
128756	9460	Thread (under) Thread Guide Holder
		Post.....
446c	9466	Thread (under) Thread Guide Holder
		Post Set Screw.....
171D	9465	Thread (under) Thread Guide Holder
		Screw.....
1498c	9466	Thread (under) Thread Guide Set Screw

NO.	PLATE	NAME
128757	-----	Thread (under) Thread Guide complete,
		Nos. 171D and 128751 to 128756.....
		NOTE: When ordering No. 128757, state
		gauge required.
128758	9460	Thread (upper) Eyelet.....
128759	9460	" " " for 128558.....
190b	9465	" " " Screw.....
50945c	9467	" " " Stud.....
2102	9461	" " Nipper Disc.....
51570c	9466	" " " Regulating
		Thumb Nut.....
128604	9459	Thread (upper) Nipper Regulator.....
190b	9465	" " " " Ad-
		justing Screw.....
32572	9461	Thread (upper) Nipper Releasing Disc..
128761	9460	" " " " Pin...
51029c	9467	" " " Screw Stud
128714	-	" " " " "
		51029c with 51570c.....
46386	9458	Thread (upper) Nipper Separating Disc.
128656	9459	" " " Spring.....
59537	9459	" " " " Bushing
		(large).....
59538	9459	Thread (upper) Nipper Spring Bushing
		(small).....
128762	9460	Thread (upper) Nipper Thread Guide..
128763	9460	" " Take-up.....
50379F	9465	" " " Set Screw.....
128764	9476	Throat Plate with 128765 and two 665D,
		for 128738.....
128612	9463	Throat Plate Holder.....
50154D	9465	" " " Screw.....
1011F	9465	" " Screw.....
1198c	9465	" " Supporting Screw.....
128765	9476	" " Thread Retainer for 128764
		NOTE: When ordering No. 128765, state
		gauge required.
665D	9465	Throat Plate Thread Retainer Screw...

ACCESSORIES

NO.	PLATE	NAME
120344	8941	Oiler (copper plated) with 120345
120345	8941	“ Spout, 5 in. long.....
26026	8941	Screw Driver (large).....
26485	8941	“ “ (small).....
128771	9464	Threading Wire, for self threading loopers
120341	8941	Tweezers (curved).....
4822	8941	Wrench for 1547.....
8908	8941	“ “ 1520.....
19079	9462	“ “ 1324.....

MACHINE BASE WITH BELT GUARD

NO.	PLATE	NAME
54356	8980	Belt Guard with 1192c.....
27347	9490	“ “ Hinge Pin.....
1192c	9467	“ “ “ “ Set Screw.....
1192c	9467	“ “ Set Screw.....
54357	8980	Machine Base with 1192c.....
51072E	9466	“ “ Bolt with 51581E.....
51581E	9466	“ “ “ Nut.....
6055	8979	“ “ “ “ Washer.....
49123	8979	“ “ Oil Pipe.....
60884	8979	“ “ “ “ Plug.....
57285	8979	“ Cushion (felt).....
948E	9466	“ Screw, to fasten machine to base
54358	—	Machine Base with Belt Guard complete, Nos. 27347, 49123, 54356, 54357, 60884, three each 6055, 51072E and four each 948E and 57285.....

EDGE FOLDERS

NO.	PLATE	NAME
120549	9485	Edge Folder on Shank, for turning the right hand edge under, for button or buttonhole facings.....
120640	9485	Edge Folder on Shank (left) for starting from bottom of garment.....
120641	9485	Edge Folder on Shank (right) for starting from neck of garment.....
120547	9452	Cloth Plate Slide.....
38416	9456	“ “ “ Spring.....
725J	9465	“ “ “ “ Screw.....
120548	—	Cloth Plate Slide Complete, Nos. 120547, two 38416 and four 725J.....
1423J	9465	Edge Folder Screw.....

FOLDER ON SHANK

NO.	PLATE	NAME
120593	9484	Folder on Shank, for making bluff centres on shirts.....
1423J	9465	Folder Screw.....

STRIP FOLDERS

STRIP FOLDERS ON BRACKET

NO.	PLATE	NAME
120633	—	Strip Folder with left hand interlining guide for 120635.....
120697	—	Strip Folder with right hand interlining guide for 120698.....
120634	9486	Strip Folder Bracket for 120635, 120637, 120698 and 120703.....
1443J	9465	Strip Folder Bracket Screw for 120635, 120637, 120698 and 120703.....
120635	9484	Strip Folder on Bracket with left hand interlining guide complete, for centre work on shirts, Nos. 120633, 120634 and two 1443J.....
120698	9486	Strip Folder on Bracket with right hand interlining guide complete, for centre work on shirts, Nos. 120634, 120697 and two 1443J.....
120636	—	Strip Folder for 120637.....
120637	9486	Strip Folder on Bracket complete, for buttonhole facings or centre work on shirts, Nos. 120634, 120636 and two 1443J.....
120702	—	Strip Folder for 120703.....
120703	9486	Strip Folder on Bracket complete, for sleeve plackets, Nos. 120634, 120702 and two 1443J.....
724b	9465	Strip Folder Hinge Screw.....
1423J	9465	“ “ Screw.....
120638	9464	“ “ Throw-out Arm.....
1377c	9467	“ “ “ “ Adjusting Screw (eccentric).....
1547J	9466	Strip Holder Throw-out Arm Adjusting Screw Nut.....
853c	9466	Strip Folder Throw-out Arm Adjusting Screw Set Screw.....
120642	9464	Strip Folder Throw-out Arm Bracket with 853c.....

NO.	PLATE	NAME
120639	9464	Strip Folder Throw-out Arm Bracket 120642 with 946d, 1377c, 1517j, 36006, 50152d and 120638, for 120635, 120637, 120698 and 120703.
50152d	9465	Strip Folder Throw-out Arm Bracket Screw.
946d	9467	Strip Folder Throw-out Arm Hinge Screw.
36006	9490	Strip Folder Throw-out Arm Hinge Screw Washer.

STRIP FOLDERS ON SHANK

NO.	PLATE	NAME
120550	9485	Strip Folder on Shank, for button stays.
120701	9487	“ “ “ “ for under facing strips, for button or buttonhole facings
120699	9487	Strip Folder Strip Guide for 120700.
120700	9487	Strip Folder on Shank with 120699 and two 1423j, for long or short strips, for sleeve or button facings.
1423j	9465	Strip Folder Strip Guide Screw for 120700
120691	9488	Strip Folder on Shank with adjustable guide using strip to fold over and turn- ing in both edges and for inserting body of garment in one operation.
120547	9452	Cloth Plate Slide.
38416	9456	“ “ “ Spring.
725j	9465	“ “ “ “ Screw.
120548	—	Cloth Plate Slide complete, Nos. 120547, two 38416 and four 725j.
1423j	9465	Strip Folder Screw.

LAP SEAM FELLERS

FOR NO. 149-2 MACHINE

NO.	PLATE	NAME
120657	9483	Lap Seam Feller on Shank (spring yield- ing) for shirt work.
120704	9483	Lap Seam Feller on Shank with two 1443j, for sleeving.
120705	9482	Feed Dog, 19 teeth (16 teeth to the inch) with 452c, for $\frac{3}{16}$ in. gauge.
120658	9481	Feed Dog, 19 teeth (16 teeth to the inch) with 452c, for $\frac{1}{4}$ in. and $\frac{5}{16}$ in. gauges.
120659	—	Presser Foot Plate for 120660.

NO.	PLATE	NAME
120660	9481	Presser Foot (hinged) complete, Nos. 18055, 120659 and 128647.
120706	9482	Throat Plate with 128724 and two 665n, for 120705.
120661	9481	Throat Plate with 128724 and two 665n, for 120658.
1443j	9465	Lap Seam Feller Screw, to fasten folder to shank, for 120704.
1423j	9465	Lap Seam Feller Screw, to fasten shank to slide.

FOOT LIFTER PARTS

NO.	PLATE	NAME
6439	—	Chain, 36 in. to 45 in., with 56864 and 56865.
NOTE: When ordering No. 6439, state length required.		
4879	8941	Chain Connecting Link.
56864	8941	“ Hook (large).
56865	9462	“ “ (small).
126249	8980	Treadle.
4882	8941	“ Shaft.
126250	8941	“ Spring.
126251	8980	“ Stand.
126252	8980	Treadle complete, Nos. 4882, 126249 to 126251 and two wood screws 1 in. No. 16.

KNEE LIFTER PARTS

NO.	PLATE	NAME
37563	—	Chain, length 15 inches, with 56864 and 56865.
56864	8941	Chain Hook (large).
56865	9462	“ “ (small).
2763	8980	Rock Shaft.
12242	8980	“ “ Hanger with two wood screws 1 in. No. 10.
6335	8980	Rock Shaft Knee Arm.
6336	—	Rock Shaft Knee Arm complete, Nos. 2766, 2767 and 6335.
2766	8980	Rock Shaft Knee Arm Hub with 356c.
356c	9467	“ “ “ “ “ Set Screw.
2767	8980	“ “ “ Plate with 356c.

NO.	PLATE	NAME
356c	9467	Rock Shaft Knee Plate Set Screw.....
6337	8980	" " Lifting Bracket with two 356c.....
7125	8980	Rock Shaft Lifting Bracket Hook.....
356c	9467	" " " " " " Set Screw.....
356c	9467	Rock Shaft Lifting Bracket Set Screw..
2770	8980	" " Stop Dog with 356c.....
356c	9467	" " " " Set Screw.....
23767	8980	Rock Shaft complete, Nos. 2763, 2770, 6336, 6337, 7125 and two 12242.....

BENCH STAND

NO.	PLATE	NAME
79757	—	Bench Stand with 27998, two each 41538, 124500, three wood screws 1¼ in. No. 14, four 60656, eight wood screws ⅝ in. No. 5 and sixteen wood screws ⅝ in. No. 7.....
124500	8952	Flap Hinge.....
27998	8952	" Hook and Eye (brass) with wood screw 1½ in. No. 5.....
126247	8952	Flush Bolt.....
126248	8952	" " Plate.....
41538	—	Flush Bolt with Plate complete, Nos. 126247, 126248 and four brass wood screws ⅝ in. No. 4.....
60656	8952	Hinge.....

TAPE HOLDERS

TAPE HOLDER

NO.	PLATE	NAME
*120671	—	Tape Reel Disc.....
120675	9489	" " " 120671 with 120676.....
*120676	—	" " " Hub.....
120677	9463	" " " Screw Stud.....
120678	9489	" " Rod.....
138B	9465	" " " Set Screw.....
27618	9489	" " Stand with 138B.....
120679	9489	" " Tape Guide.....
120682	9489	" " " " Bracket with 446c and 448c.....
446c	9466	Tape Reel Tape Guide Bracket Set Screw
448c	9466	" " " " Set Screw.....

NO.	PLATE	NAME
120681	9489	Tape Holder, 9 in. disc, complete, for interlining centering work, Nos. 27618, 120675, 120677 to 120679, 120682 and three wood screws 1¼ in. No. 12.....

TAPE HOLDER

FOR UNDER THE BENCH

NO.	PLATE	NAME
*120671	—	Tape Reel Disc.....
120672	9489	" " " 120671 with 120673.....
*120673	—	" " " Hub.....
120674	9489	" " Rod.....
28012	9490	" " Screw Eye.....
120680	9489	Tape Holder, 9 in. disc, complete, for under the bench, Nos. 28012, 120673 and 120674.....

THREAD UNWINDER

FOR FOUR SPOOLS, FOR NO. 149-2 MACHINE

NO.	PLATE	NAME
225395	8953	Spool Rest (for two spools) with 201018
225388	8953	" " Rod.....
200383c	9467	" " " Set Screw.....
201018c	9467	" " Set Screw.....
202490	8953	" Stand with 200383c.....
225391	8953	Thread Guide.....
201696d	9467	" " Lock Nut.....
225392	8953	" " Rod with 208E and 225393
208E	9465	" " " Screw.....
225393	9467	" " " Washer.....
225398	8953	Thread Unwinder complete, Nos. 201696d, 202490, 225388, 225392, two 225395, four 225391 and three wood screws 7⁄8 in. No. 12.....
27739	9464	Thread Cone (wood), for large cones...
225390	—	" " Holder, for inverted cones

NOTE: Nos. 27739 and 225390 are used with,
but not included in 225398

THREAD UNWINDER

FOR EIGHT SPOOLS, FOR NO. 149-4 MACHINE

NO.	PLATE	NAME
27623	7931	Spool Pin.....
155c	9465	“ “ Set Screw.....
41534	7931	“ Rest.....
41535	—	“ “ 41534 with 4149c and four each 155c and 27623.....
1149c	9465	Spool Rest Set Screw.....
202490	7931	“ Stand with 200383c.....
27739	7931	Thread Cone (wood).....
41633	7931	“ Guard with 208E and four 41569.....
41569	9458	“ “ Eyelet.....
41638	7931	“ “ Rod.....
60300	7931	“ “ “ Connection with two 453c.....
453c	9466	Thread Guard Rod Connection Set Screw.....
200383c	9467	“ “ “ Set Screw.....
208E	9465	“ “ Screw.....
41635	9490	“ “ Tension Bracket with 175D.....
175D	9465	“ “ “ “ Set Screw.....
41636	—	Thread Guard Tension Bracket complete, Nos. 418D, 1562J, 41635, 43808 and two 2455.....
2455	9458	Thread Guard Tension Disc.....
418D	9467	“ “ “ Screw Stud.....
1562J	9466	“ “ “ “ “ Regulating Thumb Nut.....
43808	9490	Thread Guard Tension Spring.....
60301	7931	Thread Unwinder complete, Nos. 60300, 202490, two each 41535, 41633, 41638, three wood screws 1 in. No. 12 and eight each 27739 and 41636.....

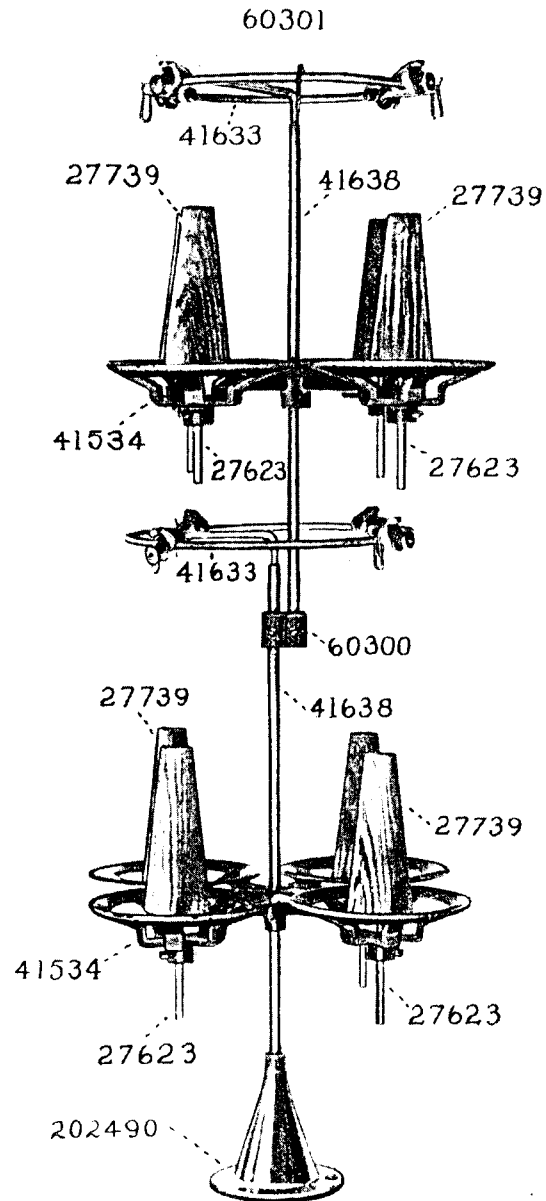
OBSOLETE PARTS

FOR MACHINE NO. 149-2

NO.	PLATE	NAME
128637	9477	Feed Dog, 19 teeth (16 teeth to the inch) with 452c, for $1\frac{1}{8}$ in. to 1 in. gauges..
128661	9478	Feed Dog, 19 teeth (16 teeth to the inch) with 452c, for $1\frac{1}{16}$ in. to $1\frac{1}{4}$ in. gauges..
128700	9479	Feed Dog, 19 teeth (16 teeth to the inch) with 452c, for $1\frac{1}{2}$ in. to $\frac{5}{8}$ in. gauges..
128705	9480	Feed Dog, 19 teeth (16 teeth to the inch) with 452c, for $1\frac{3}{8}$ in. to $1\frac{1}{2}$ in. gauges..

NO.	PLATE	NAME
128639	9490	Looper (closed eye).....
128642	9490	“ Eccentric with two 889c, use 128728.....
889c	9466	Looper Eccentric Set Screw.....
128553	—	Needle Bar 57244 with 128565, use 128766.....
128565	9490	Needle Clamp with 128566, 128620 and two each 460E and 620E, use 128767..
128566	9490	Needle Clamp Thread Guide (left).....
620E	9466	“ “ “ “ “ Screw.....
128620	9490	“ “ “ “ “ (right).....
620E	9466	“ “ “ “ “ Screw.....
460E	9466	“ Set Screw.....
54108	—	Oil Tube.....
128644	—	“ “ and Thread Guide Bracket.....
128645	9464	Oil Tube and Thread Guide Bracket complete, Nos. 49092, 54108, 128644 and 128657, use 128725.....
128646	—	Presser Foot Plate for 128648.....
128648	9490	Presser Foot (hinged) complete, Nos. 18055, 128646 and 128647, use 128719.....
128588	9490	Slack Thread Regulator.....
128655	9490	Thread (upper) Eyelet for 128558.....
*128657	—	“ “ Guide for 128645.....
128610	9490	“ “ Take-up.....
54095	9490	“ “ “ Thread Retainer.....
1449a	9467	Thread (upper) Take-up Thread Retainer Screw.....
54716	9458	Thread (upper) Take-up Thread Retainer Spring.....
128658	9477	Throat Plate with 128659 and two 665D, for 128637.....
128662	9478	Throat Plate with 128659 and two 665D, for 128661.....
128701	9479	Throat Plate with 128659 and two 665D, for 128700.....
128706	9480	Throat Plate with 128659 and two 665D, for 128705.....
128659	9479	Throat Plate Thread Retainer for 128658, 128662, 128701 and 128706.....

PLATE 7931—ONE-SIXTH SIZE



From the library of: Diamond Needle Corp

PLATE 8941—ONE-HALF SIZE

19221 8908 120344 26485 38487

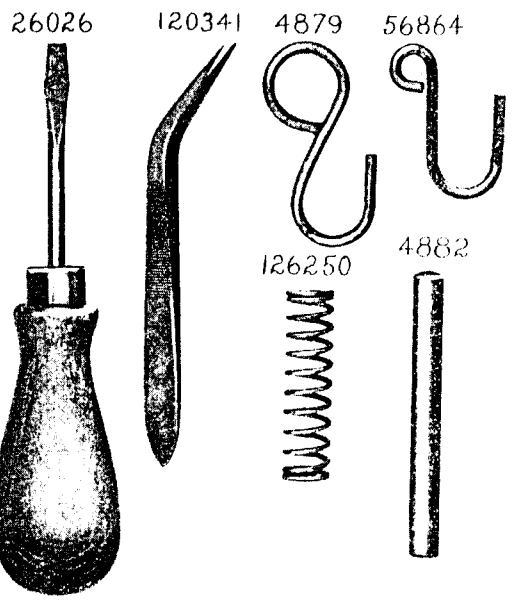
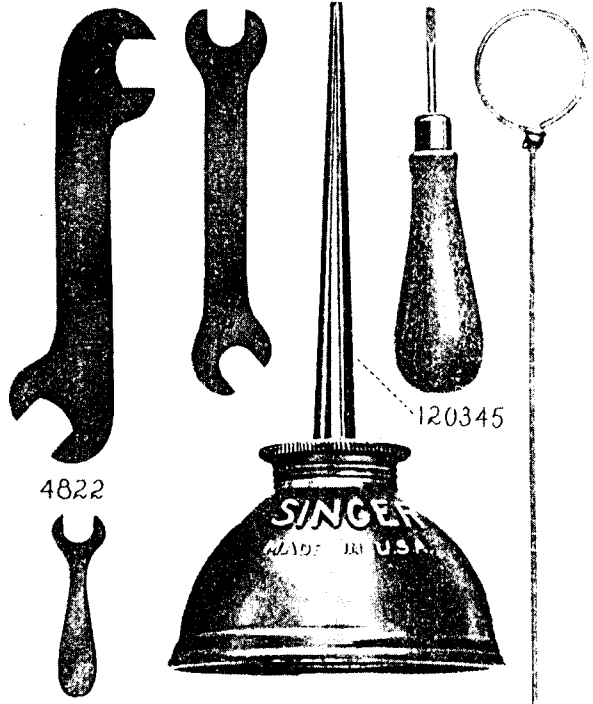
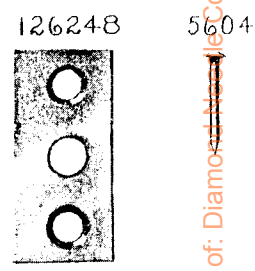
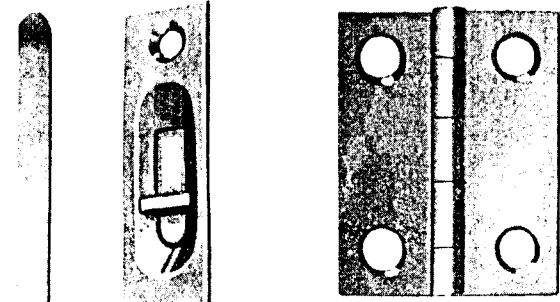
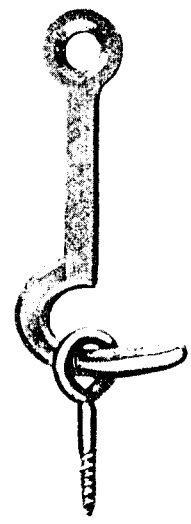


PLATE 8952—FULL SIZE

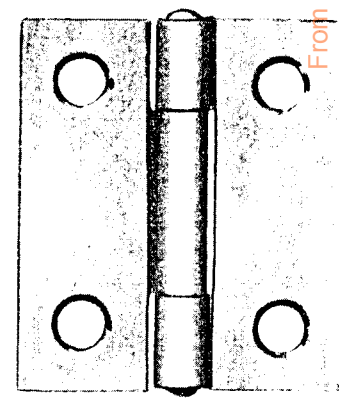
9370 126247 124500



27998



60656



From the library of: Diamond Steel Corp

PLATE 8953—ONE-SIXTH SIZE

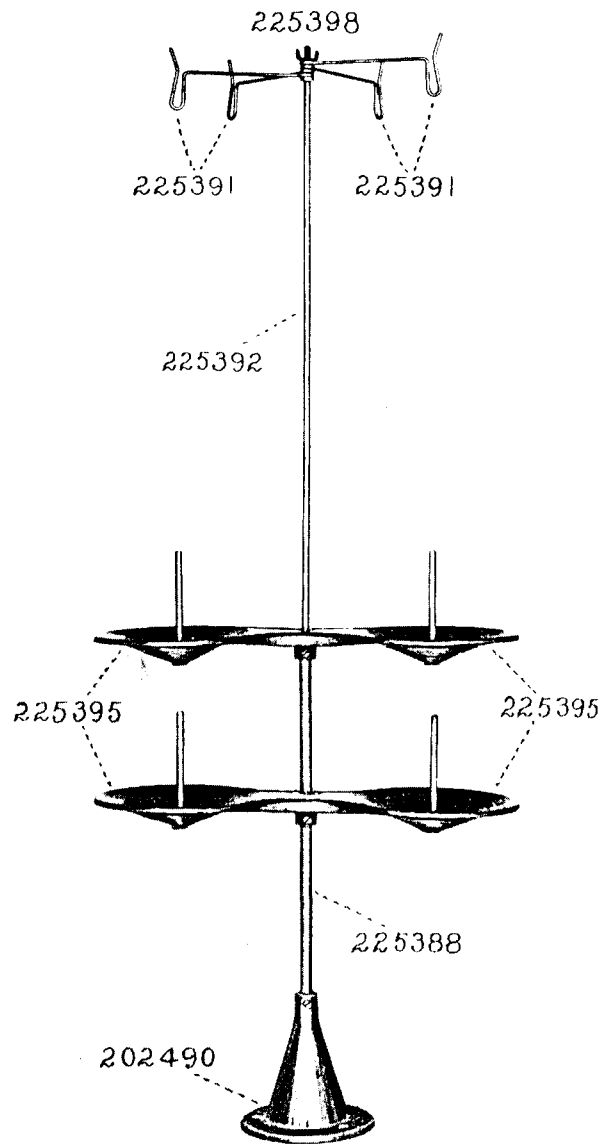
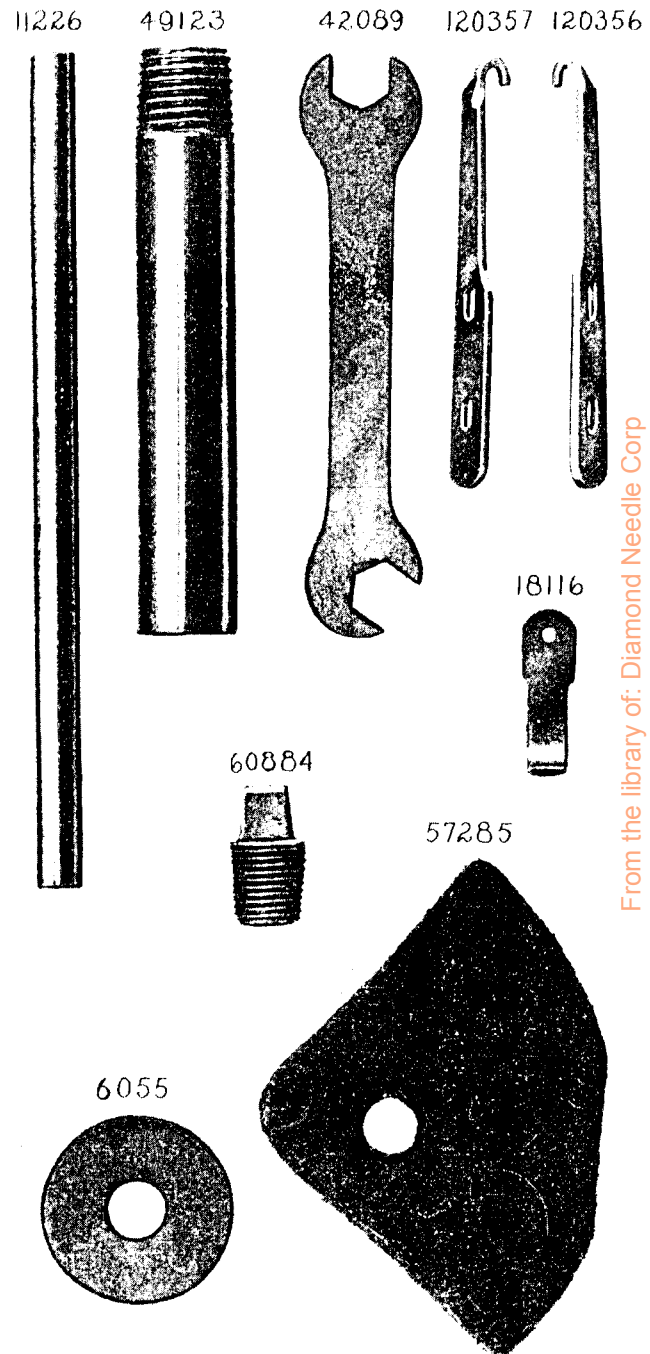


PLATE 8979—FULL SIZE



From the library of: Diamond Needle Corp

PLATE 8980—ONE-FOURTH SIZE

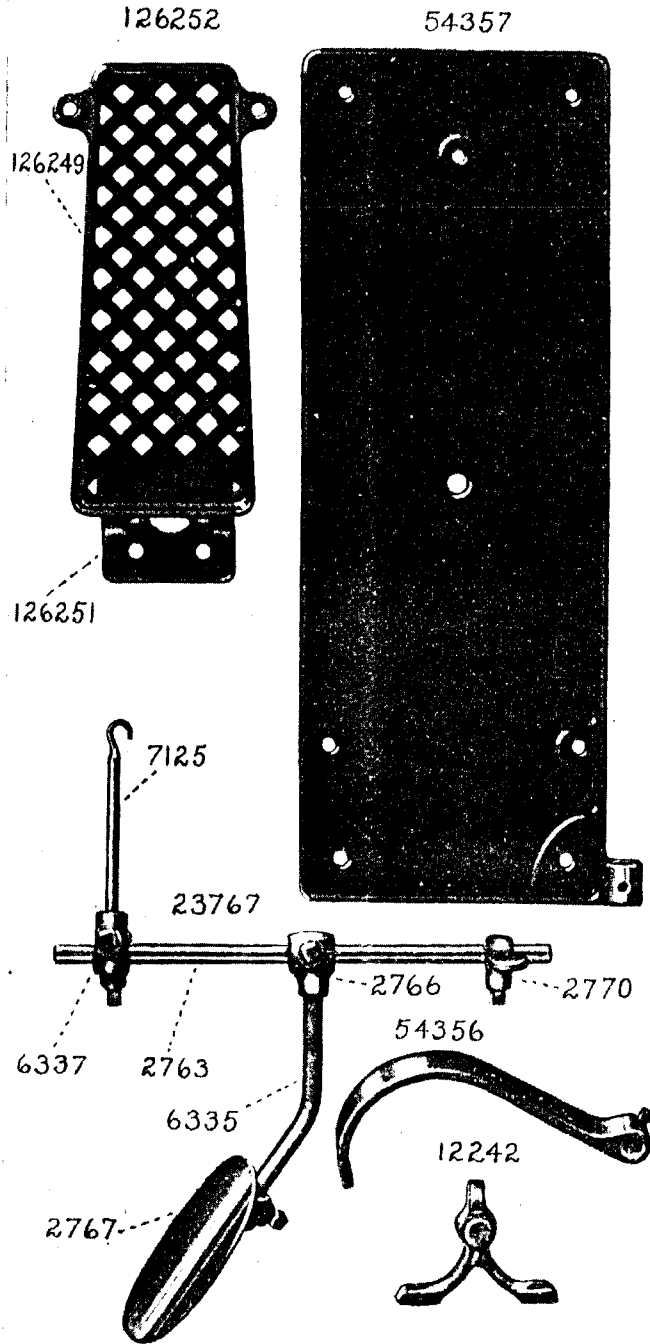
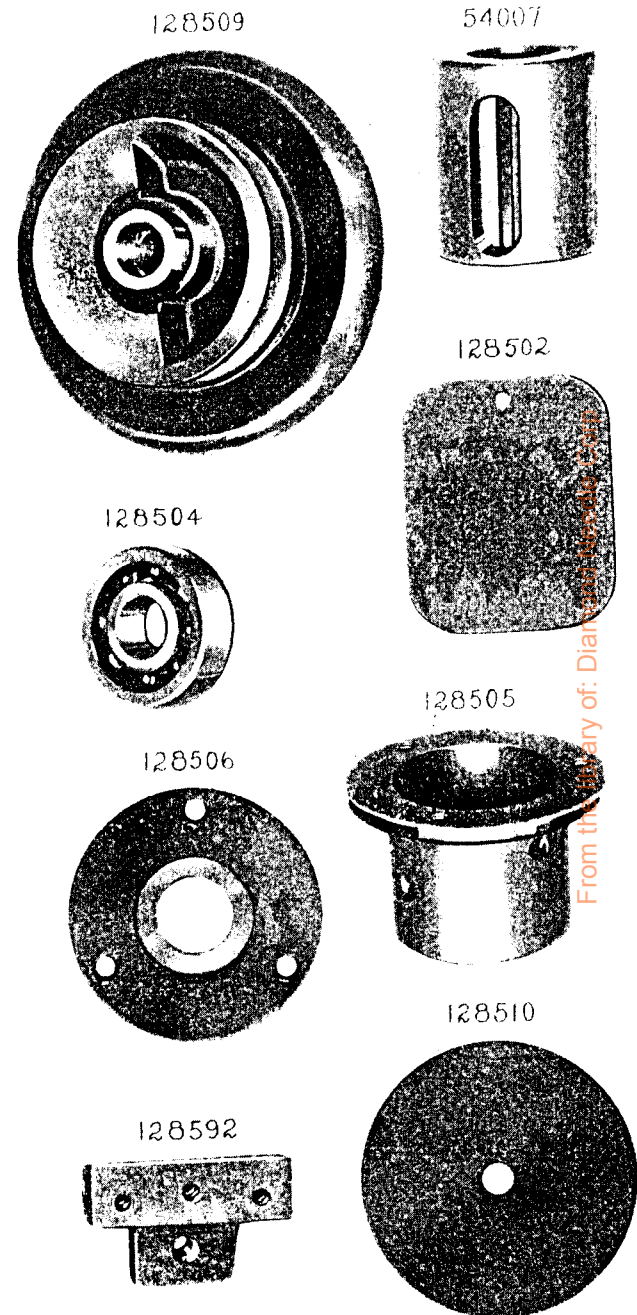


PLATE 9451—ONE-HALF SIZE



From the Library of: [Diary of a Librarian](https://www.industrydocuments.ucsf.edu/docs/8980)

PLATE 9452—ONE-FOURTH SIZE

128503



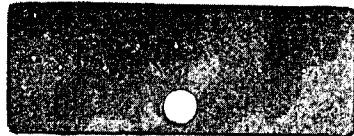
128584



128558



128514



120547



128633

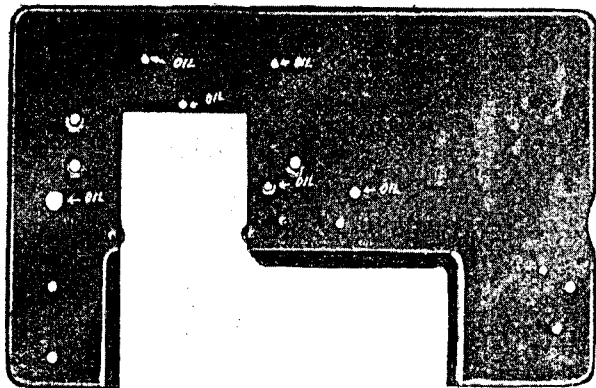
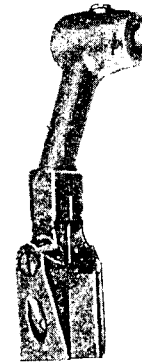


PLATE 9453—ONE-HALF SIZE

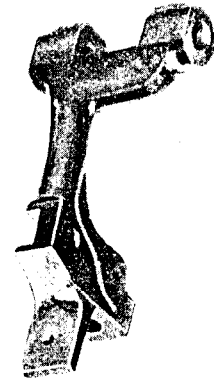
57225



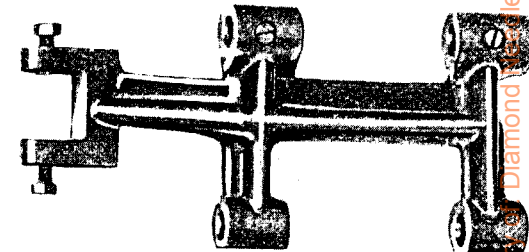
128520



128635



128533



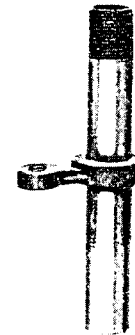
128534



128545



128544



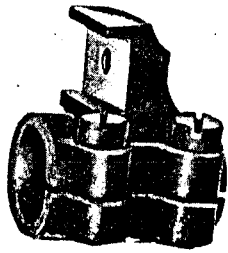
128562



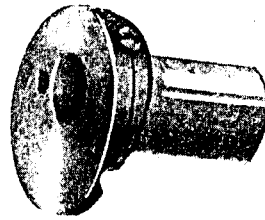
From the library of Diamond Tool Corp

PLATE 9454—FULL SIZE

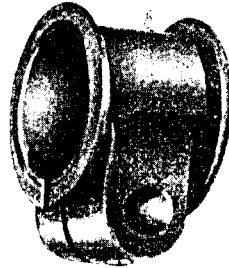
128543



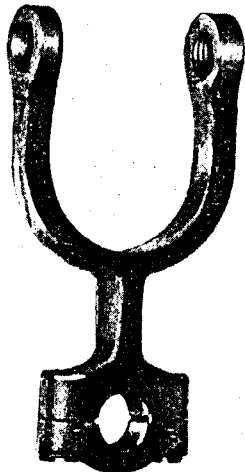
128638



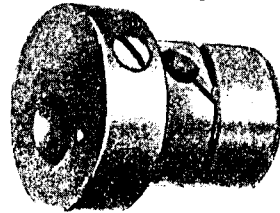
128549



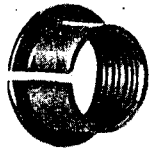
128550



128728



128546



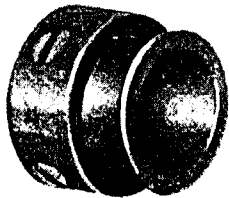
128547



679



128508



128519



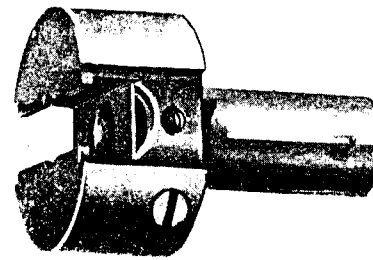
128551



1520

PLATE 9455—FULL SIZE

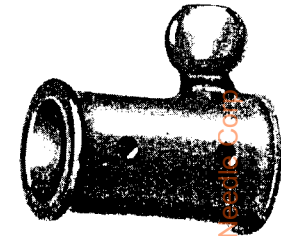
128527



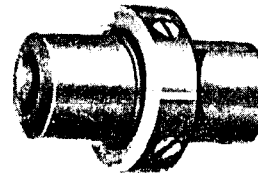
128522



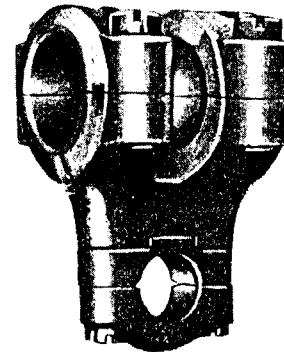
128537



128641



128621



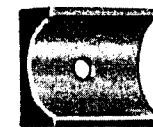
128526



128521



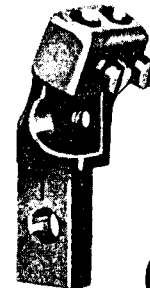
128518



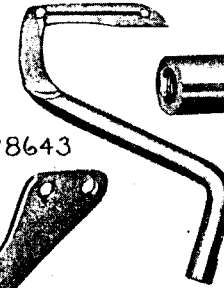
128531



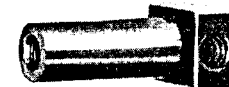
128640



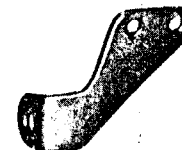
128717



128530



128643



128532



PLATE 9456—FULL SIZE

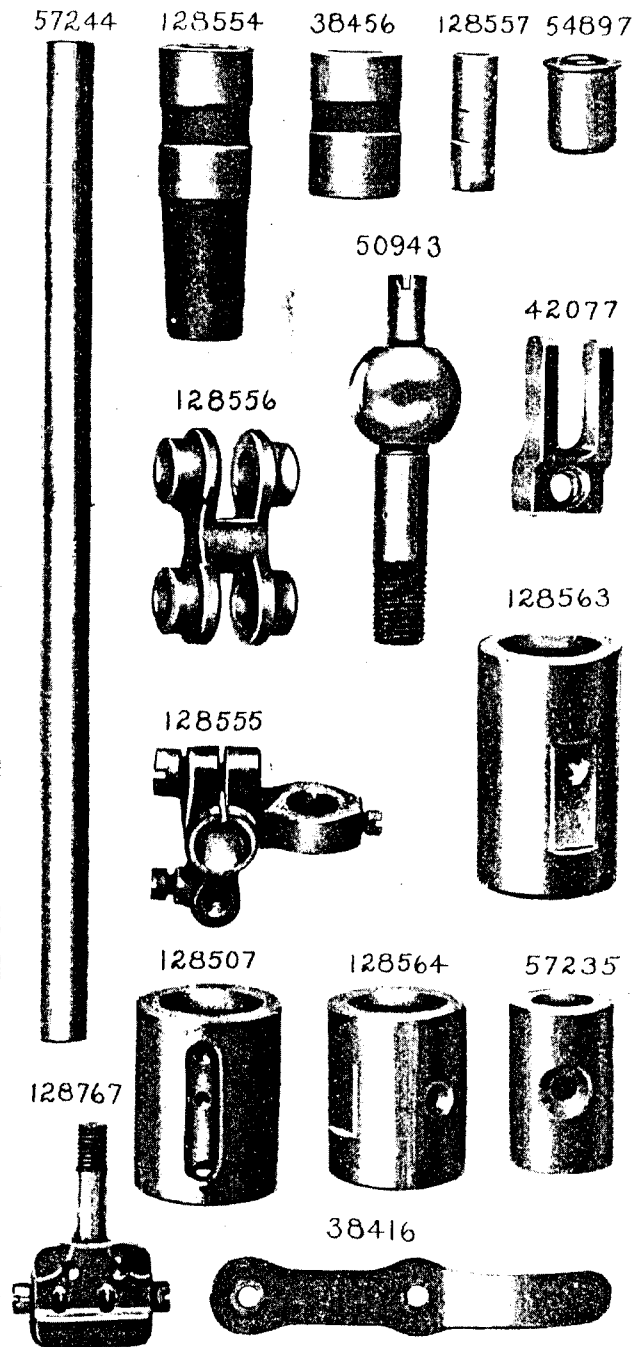
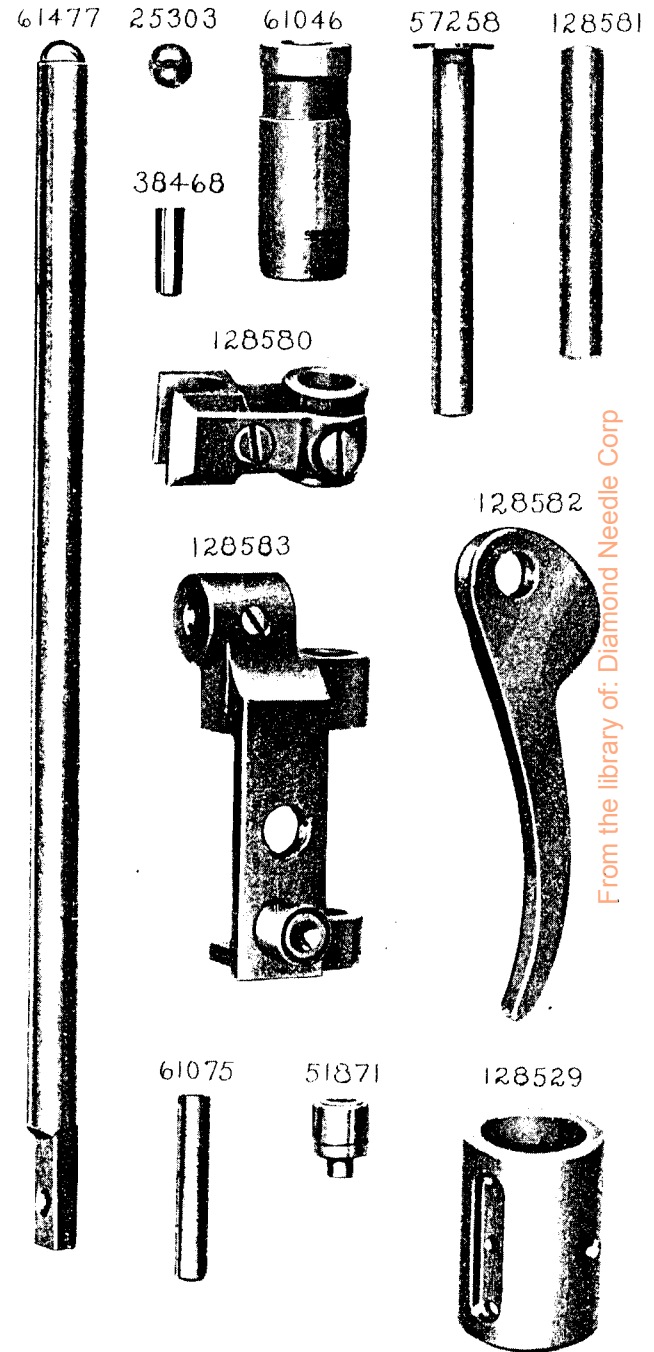


PLATE 9457—FULL SIZE



From the library of: Diamond Needle Corp

PLATE 9458—FULL SIZE

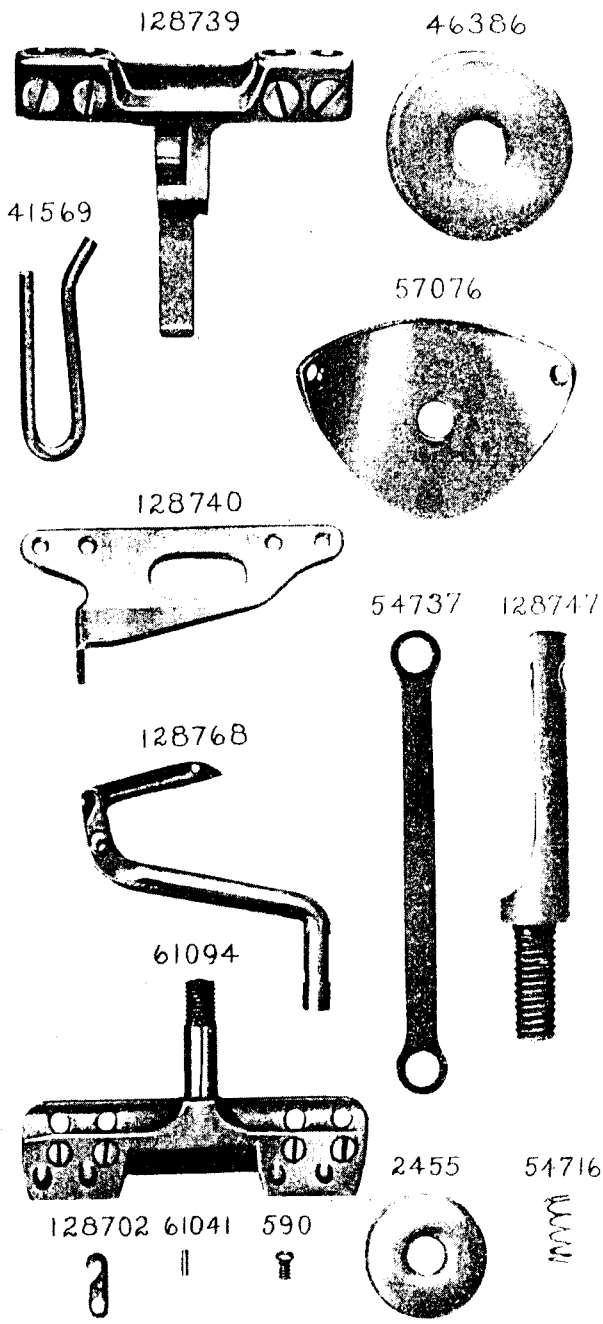
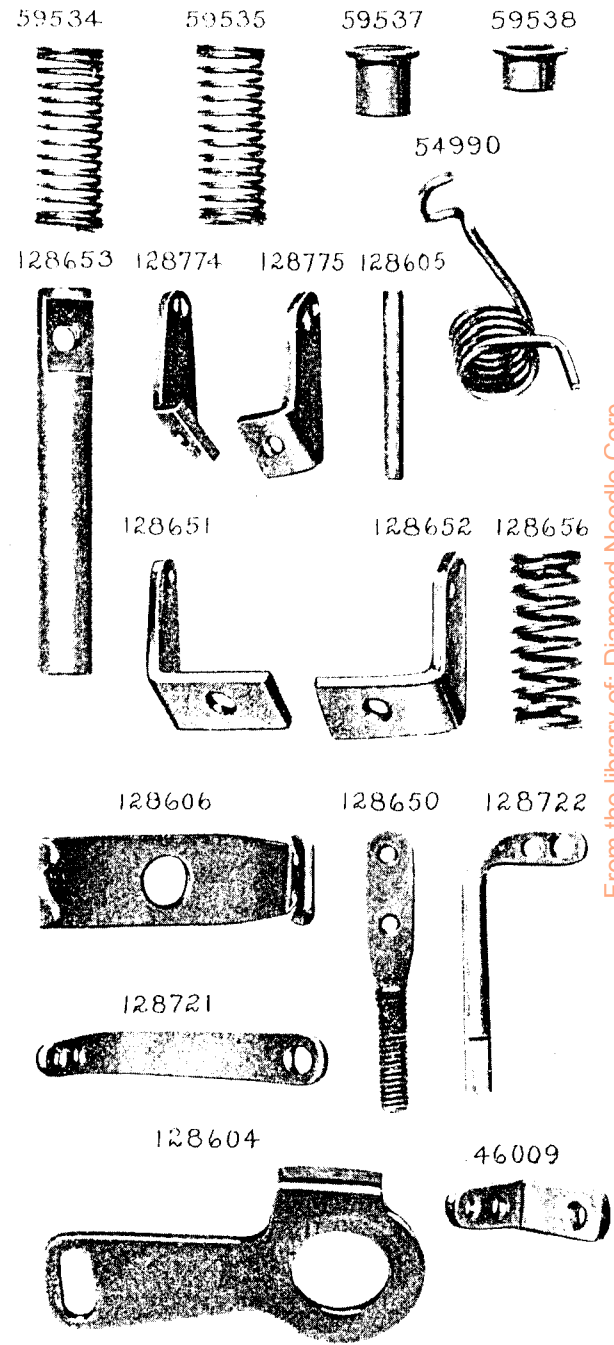


PLATE 9459—FULL SIZE



From the library of: Diamond Needle Corp

PLATE 9460—FULL SIZE

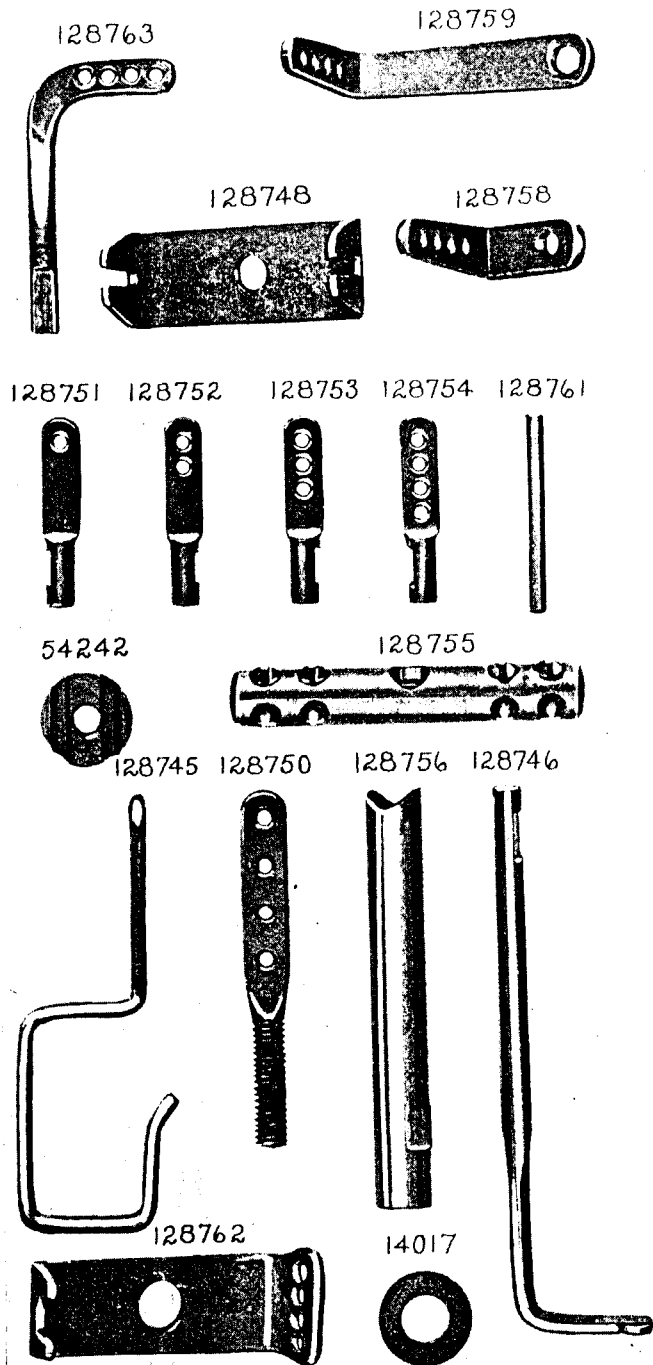
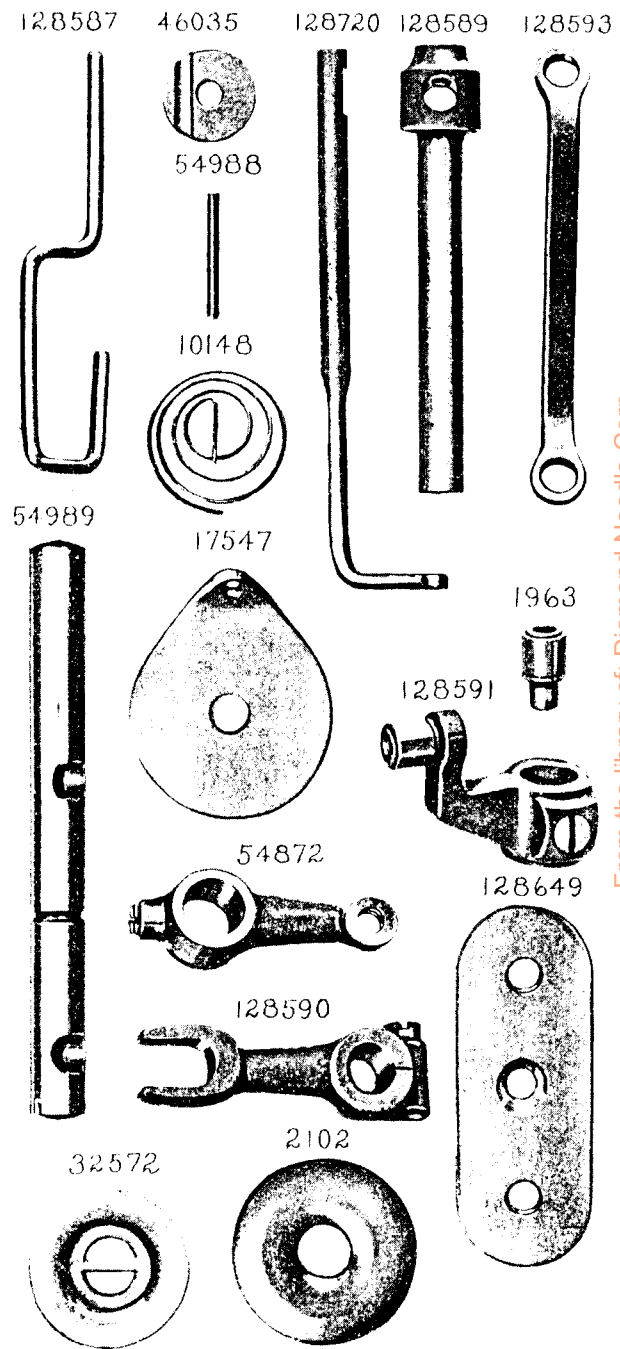


PLATE 9461—FULL SIZE



From the library of: Diamond Needle Corp

PLATE 9462—FULL SIZE

64508



128628



55515



49013



54648



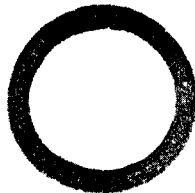
64805



42366



128619



49092



41036



128571



128513



56865

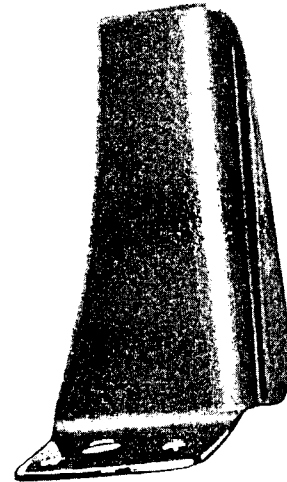


19079



PLATE 9463—ONE-HALF SIZE

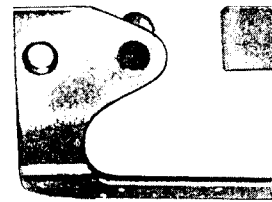
128654



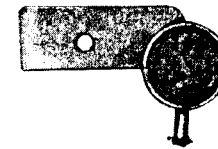
128569 44006 128559



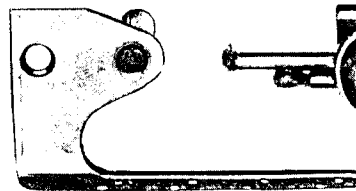
128725



128568



128741



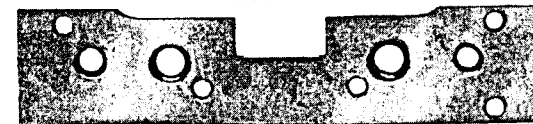
128573



120677



128612



Property of: Diamond Needle Corp

PLATE 9464—ONE-HALF SIZE

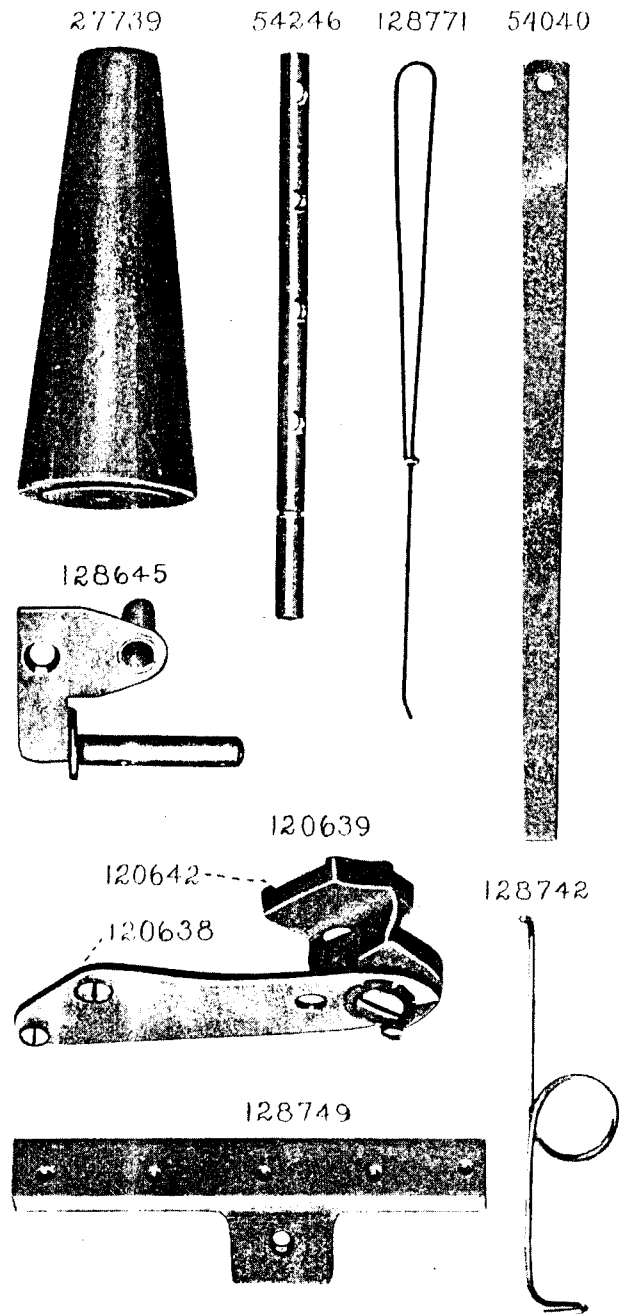
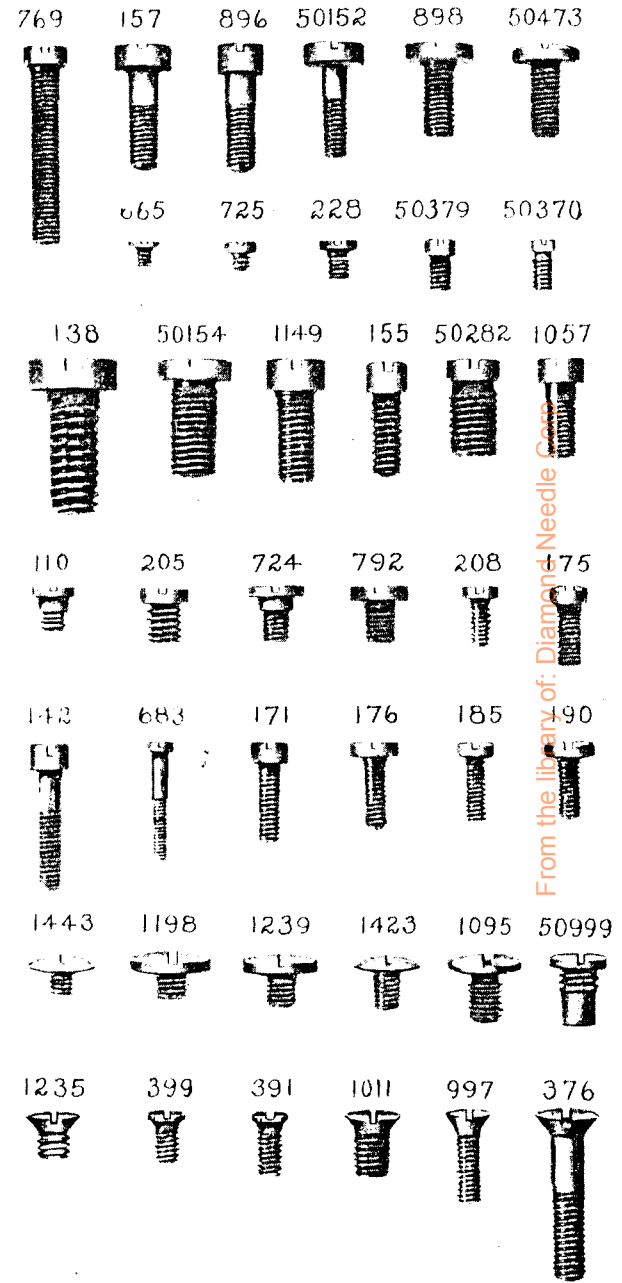


PLATE 9465—FULL SIZE



From the library of: Diamond Needle Co.

PLATE 9466—FULL SIZE

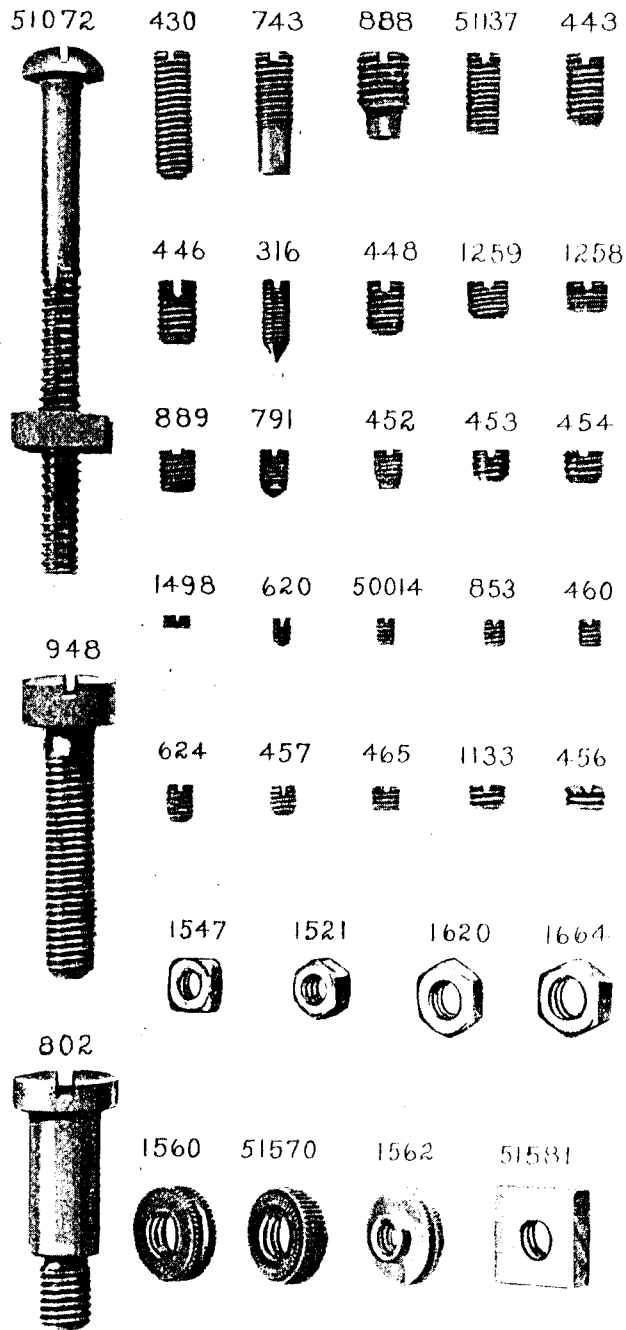
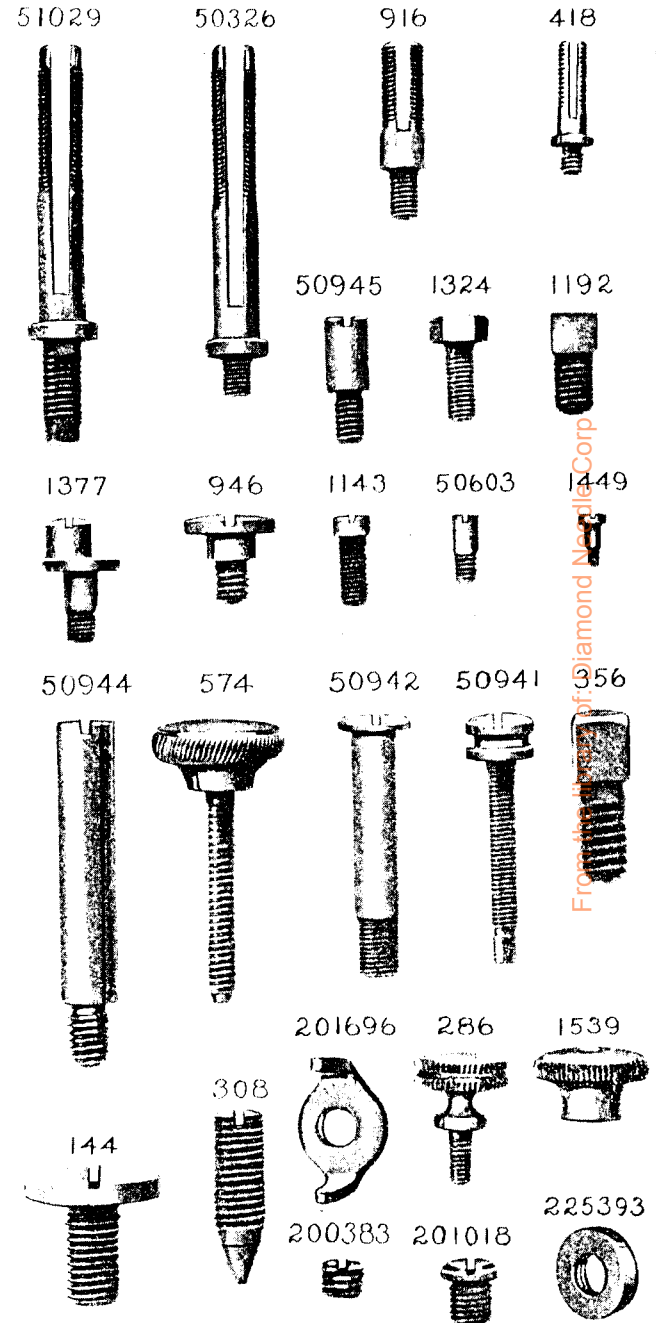


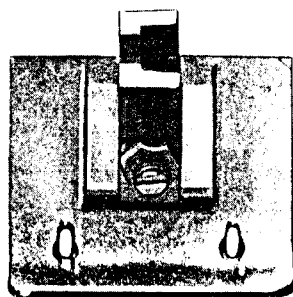
PLATE 9467—FULL SIZE



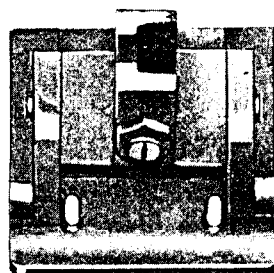
From the files of Diamond Needle Corp

PLATE 9468—FULL SIZE

128719



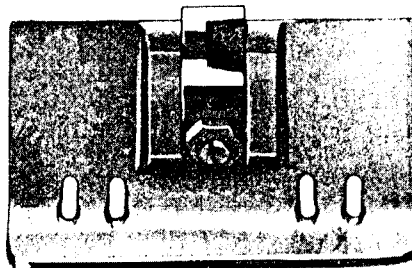
128736



128734

128733

128744



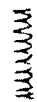
18055



1145



2656



62527



563



1700

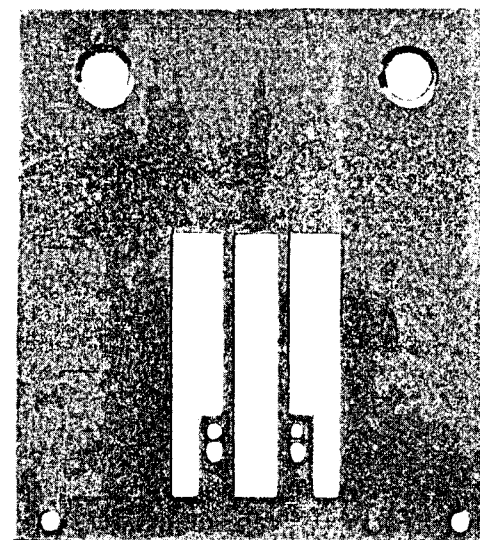


PLATE 9469—FULL SIZE

128772



128773



From the library of: Diamond Needle Corp

PLATE 9470—FULL SIZE

128729

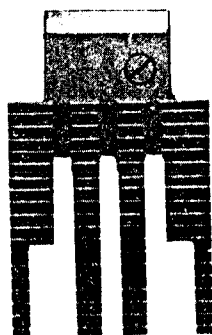
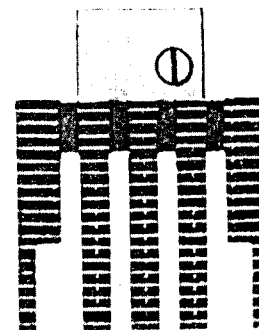
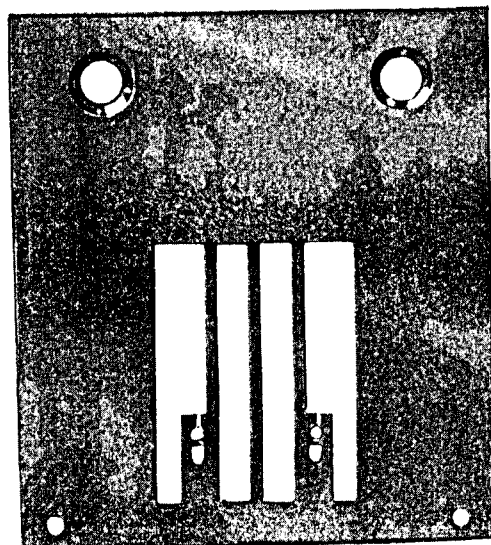


PLATE 9471—FULL SIZE

128716



128730



128723

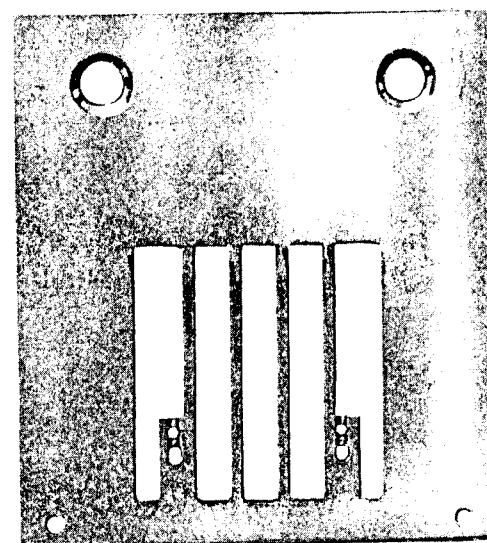
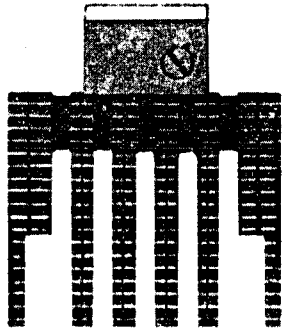
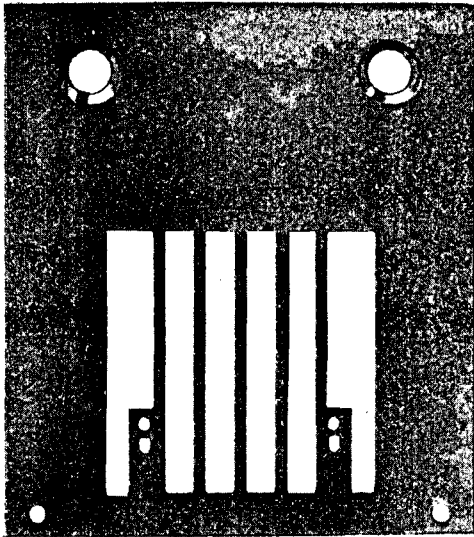


PLATE 9472—FULL SIZE

128726



128727

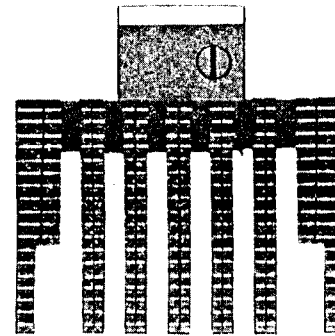


128724



PLATE 9473—FULL SIZE

128731



128732

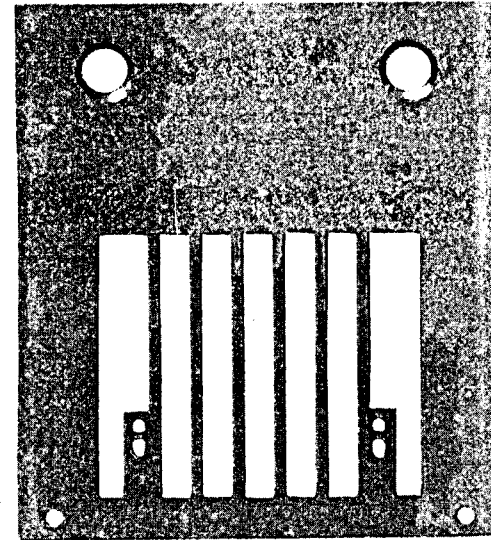
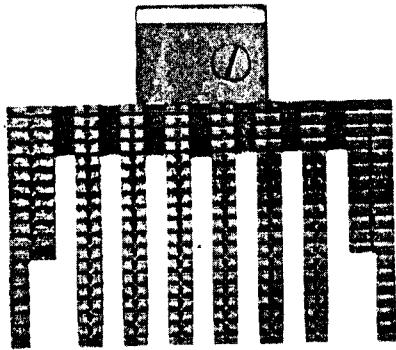


PLATE 9474—FULL SIZE

128821



128822

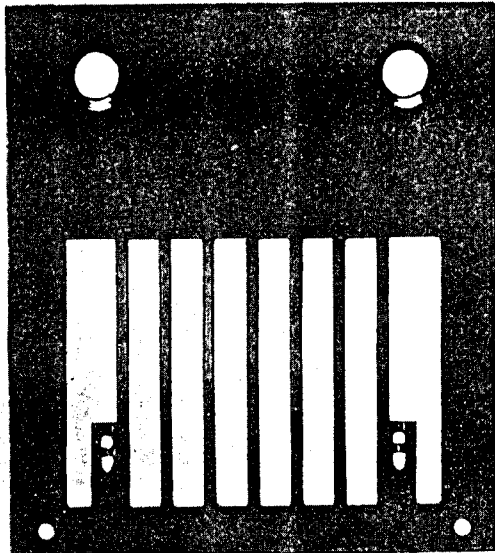
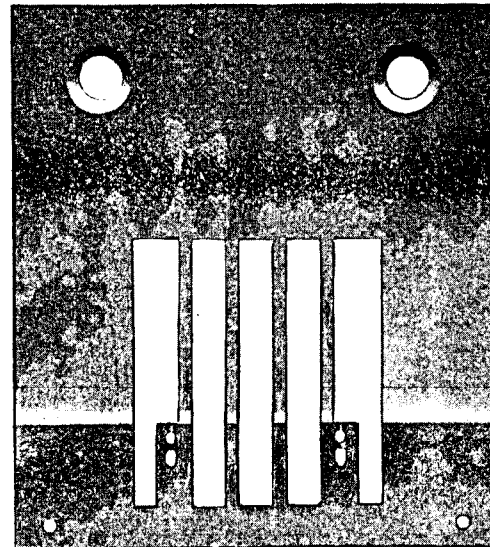


PLATE 9475—FULL SIZE

128737



128770

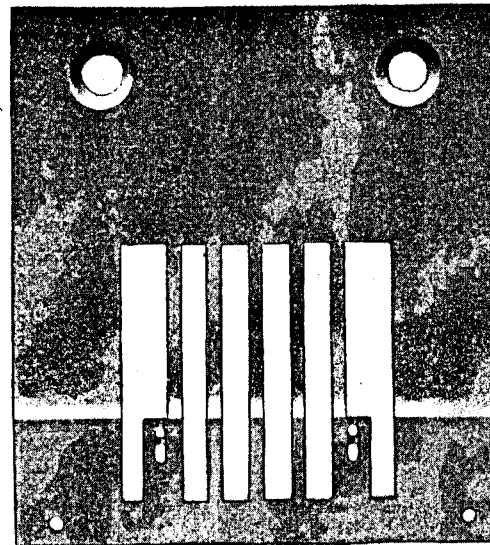
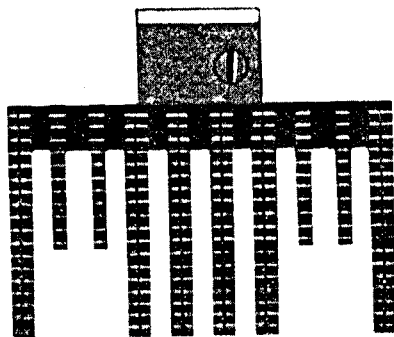
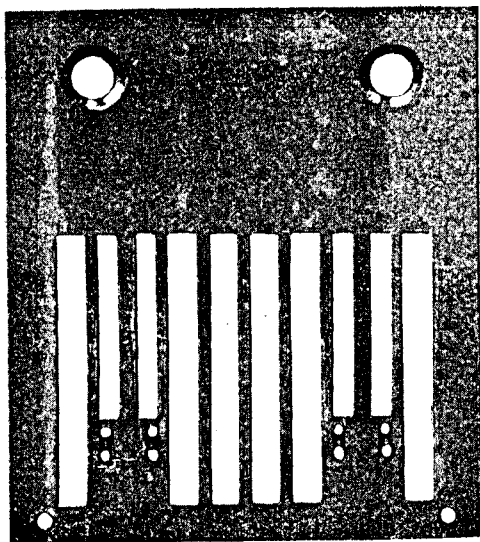


PLATE 9476—FULL SIZE

128738



128764

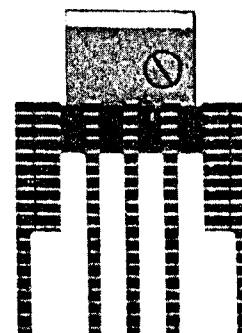


128765

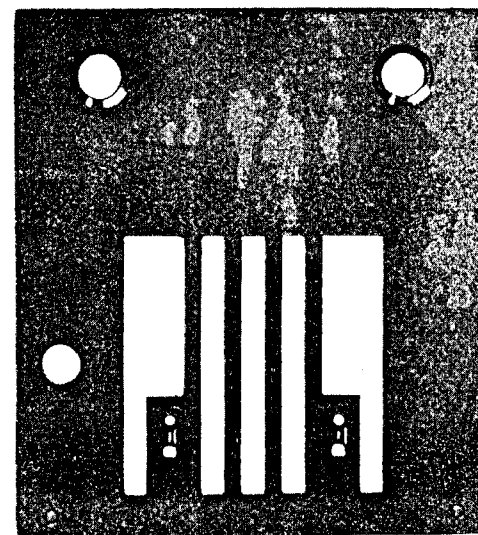


PLATE 9477—FULL SIZE

128637



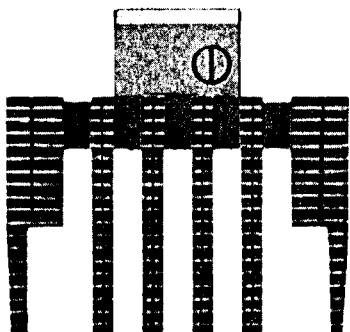
128658



From the library of: Diamond Needle Corp

PLATE 9478—FULL SIZE

128661



128662

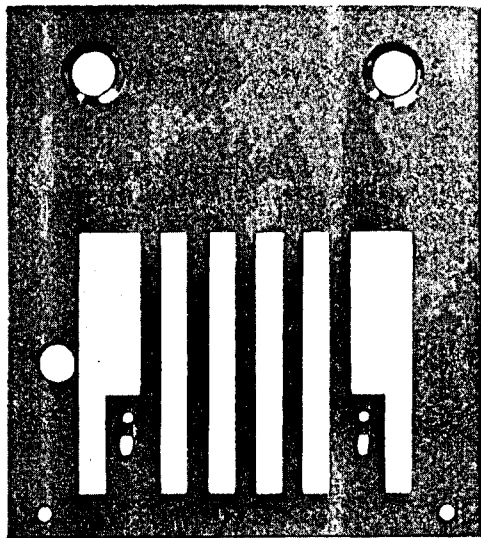
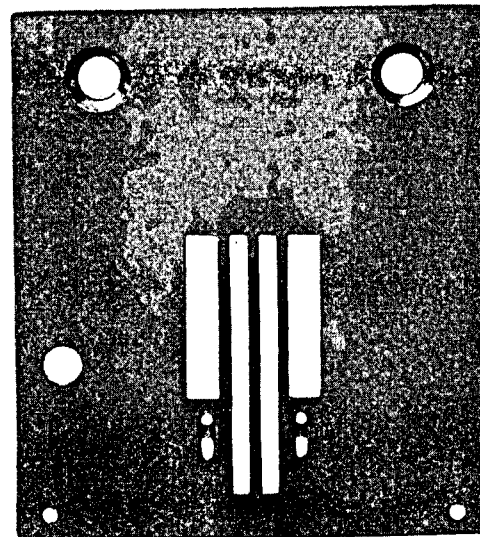


PLATE 9479—FULL SIZE

128700



128701



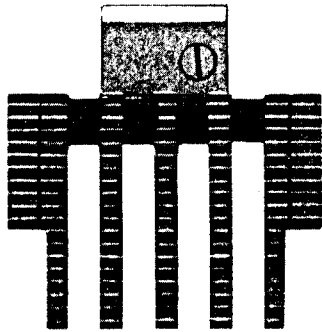
128659



From the library of: Diamond Needle Corp

PLATE 9480—FULL SIZE

128705



128706

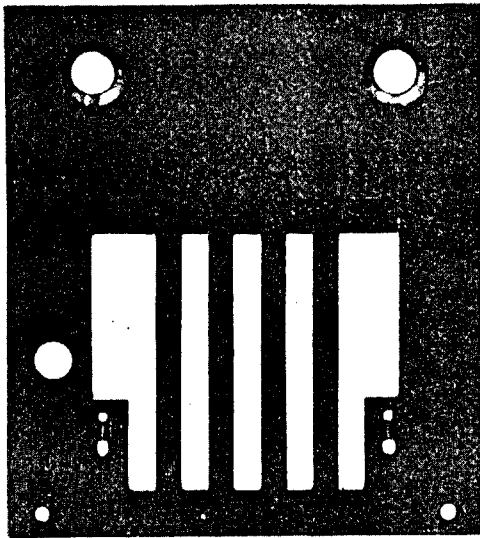


PLATE 9481—FULL SIZE

120660



120658



120661

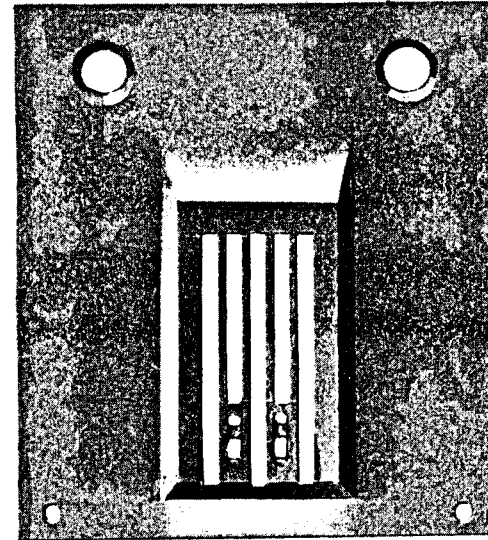
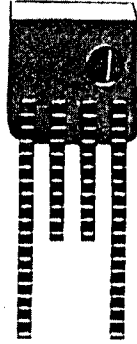


PLATE 9482—FULL SIZE

120705



120706

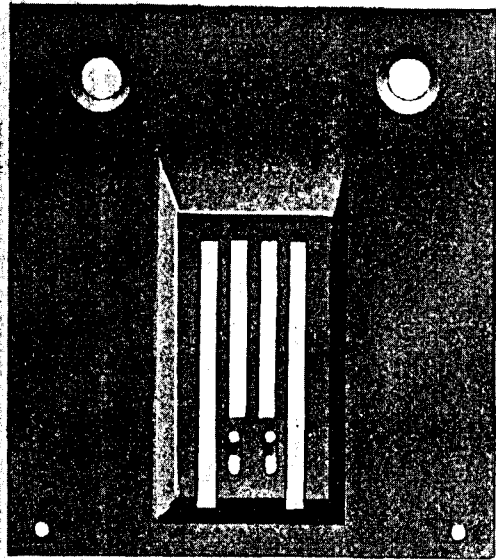
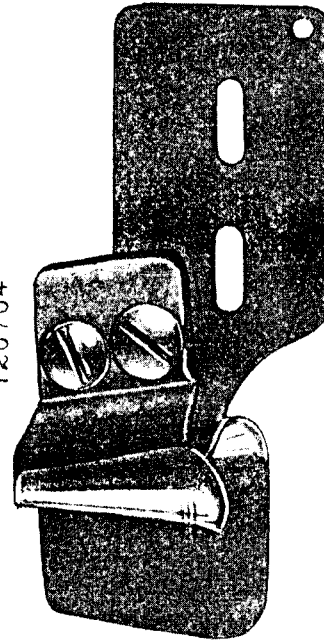
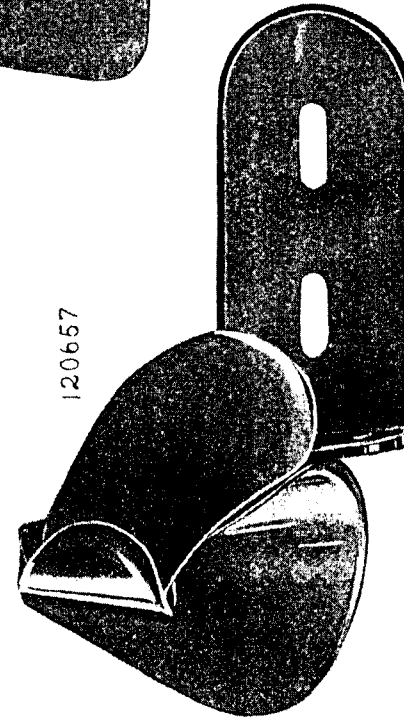


PLATE 9483—FULL SIZE

120704



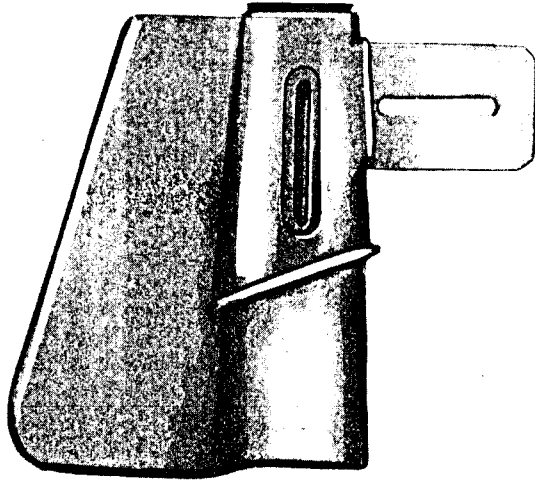
120657



From the library of: Diamond Needle Corp

PLATE 9484—ONE-HALF SIZE

120593



120635

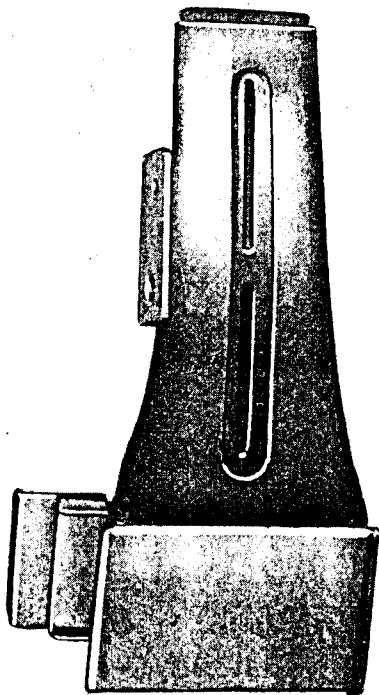
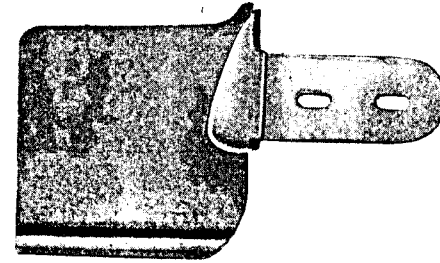
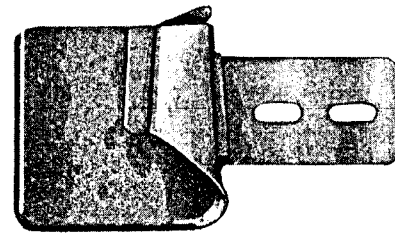


PLATE 9485—ONE-HALF SIZE

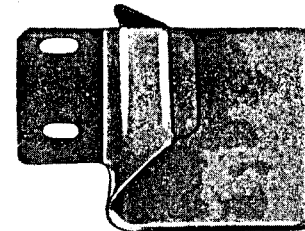
120549



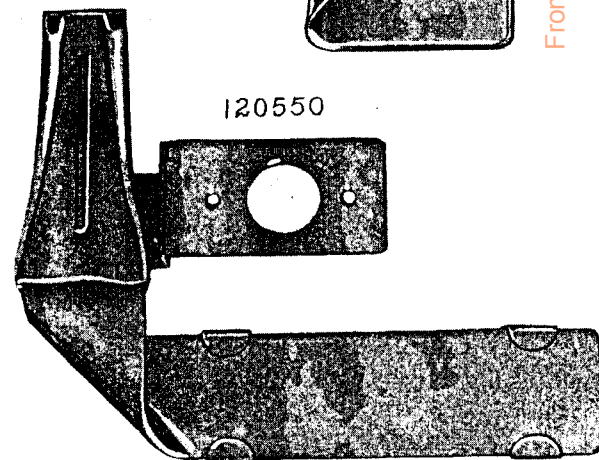
120640



120641



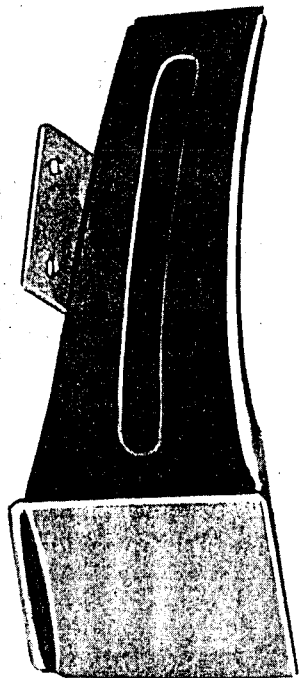
120550



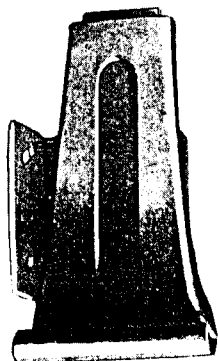
From the library of: Diamond Needle Corp

PLATE 9486—ONE-HALF SIZE

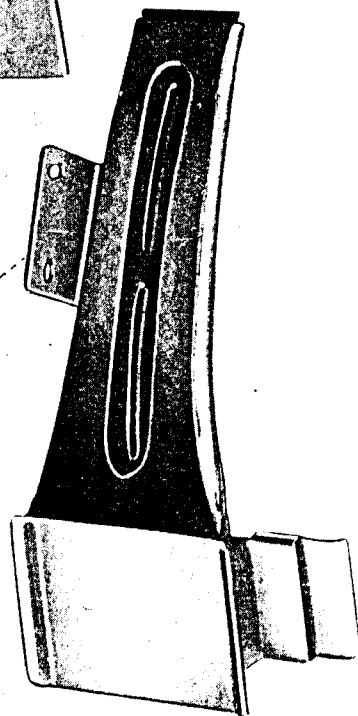
120637



120703



120698

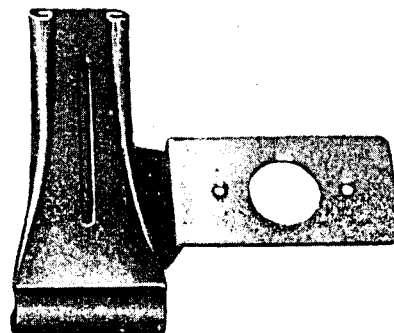


120634

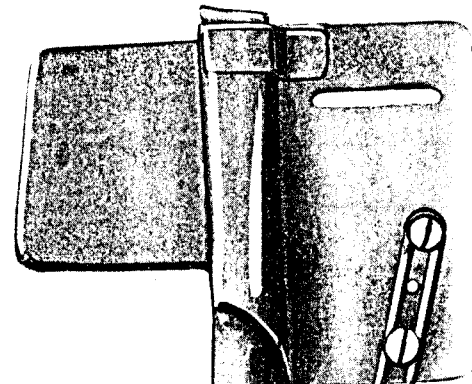


PLATE 9487—ONE-HALF SIZE

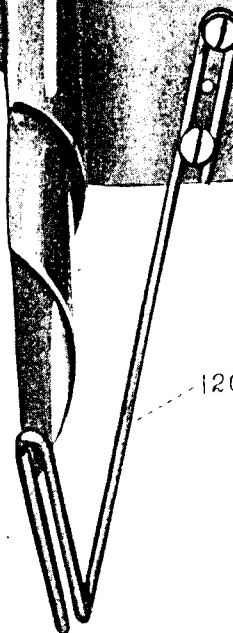
120701



120700



120639



From the library of: Diamond Needle Corp

PLATE 9488—ONE-HALF SIZE

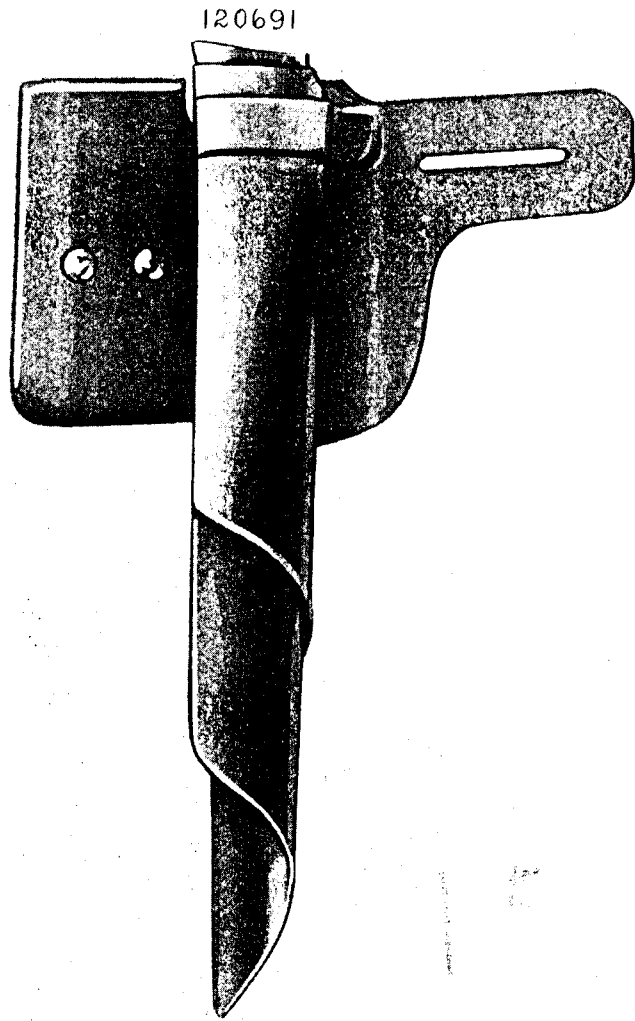
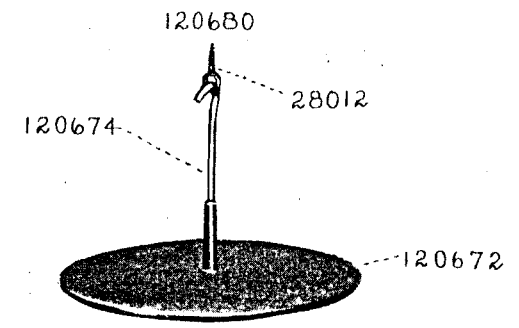
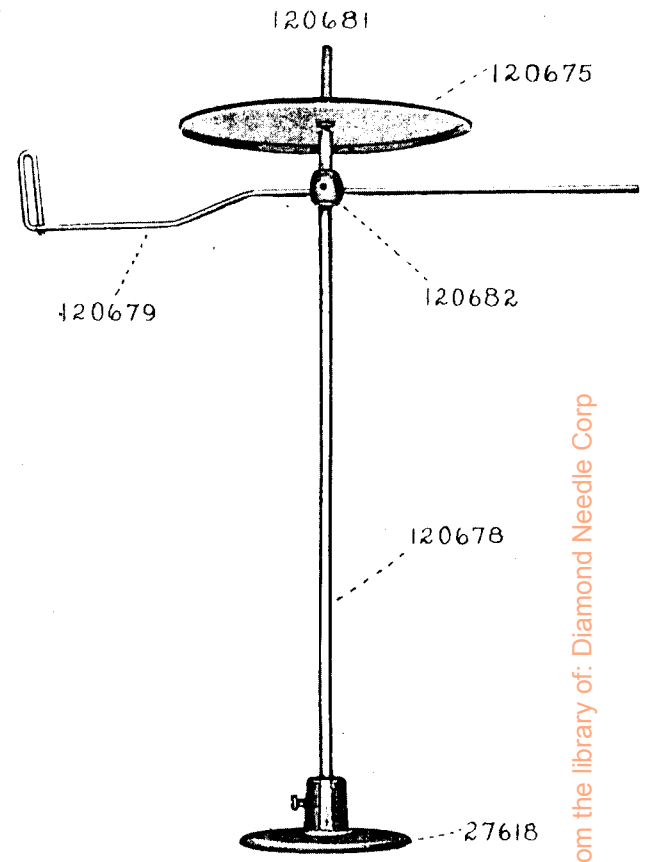


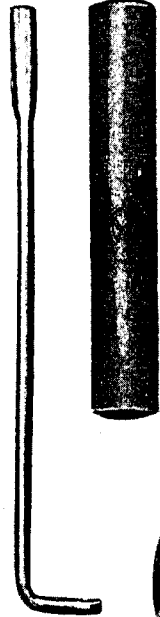
PLATE 9489—ONE-SIXTH SIZE



From the library of: Diamond Needle Corp

PLATE 9490—FULL SIZE

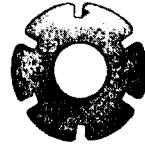
128588 27347



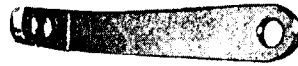
128610 54-095 43808



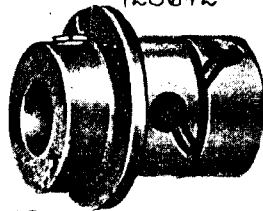
36006



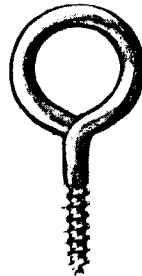
128655



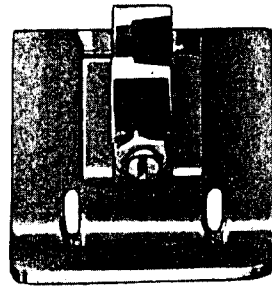
128642



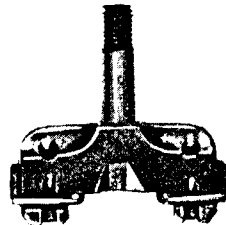
28012



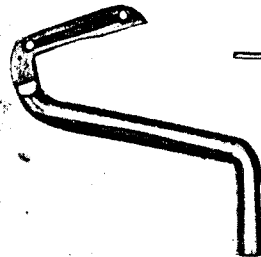
128648



128565



128639



128566



128620



41635

